

# RUUKKI GAMINIŲ KAINORAŠTIS

Galioja nuo 2024 04 15





## Turinys

Kokybės klasės .....	3	Paslėptoji lietaus nuvedimo sistema .....	28–30
Stogo dangos .....	4–7	Stogo saugos elementai .....	31–33
Stogo lankstiniai Classic profiliams .....	8–10	Vielinio lyno sistema Ruukki Safeline .....	34
Stogo lankstiniai čerpiams ir profiliuotiems lakštams....	11–14	Profiluoti lakštai .....	35–36
Stogo lankstiniai Classic profiliams .....	15–10	Stogo pakalimai .....	37
Sraigčiai, plėvelės, sandarinimo juostos .....	20–21	Lygi skarda .....	38
Dažai, kaminėliai, įvadai .....	22–23	Classic profilių palyginimo lentelė .....	39
Lietaus vandens nuvedimo sistemos .....	24–27		

## Ruukki kokybės klasės – tai ne vien produkto charakteristikos

Ruukki kokybės klasė – tai ne tik produkto originalumo, kokybės ir ilgamžiškumo ženklas. Tai – ilgamečio rinkos lyderio pažadas, kad stogo įsigijimas vyks užtikrinant aukščiausią aptarnavimo kokybę, projektavimo ir tiekimo sklandumą. Mūsų gaminių asortimentas yra labai didelis, todėl tikimės, kad jums pavyks rasti norimą sprendimą savo stogui.

- ● ● ● ● puiki
- ● ● ● ○ labai gera
- ● ● ○ ○ gera
- ● ○ ○ ○ patenkinama



Kokybės klasė	Ruukki® 50 Plus	Ruukki® 40	Ruukki® 30 Plus	Ruukki® 30
Polimerinė danga	GreenCoat Pural BT Matt	GreenCoat Crown BT	Rough Matt Polyester	Polyester
Polimerinės dangos paviršius	Struktūriškas	Smulkios struktūros	Struktūriškas	Lygus
Išvaizda	Matinė	Pusiau matinė	Matinė	Blizgi
Nominalus polimerinės dangos storis (µm)	50	26	30	25
Atsparumas UV spinduliotei	● ● ● ● ● Ruv5	● ● ● ● ○ Ruv3	● ● ● ● ○ Ruv3	● ● ○ ○ ○ Ruv2
Atsparumas korozijai	● ● ● ● ● RC5+	● ● ● ● ○ RC4	● ● ● ● ○ RC4	● ● ● ○ ○ RC3
Atsparumas įbrėžimams	● ● ● ● ● ≥ 4,000 g	● ● ● ● ○ ≥ 2,500 g	● ● ● ● ○ ≥ 2,500 g	● ● ● ○ ○ ≥ 2,000 g
Minimalus leistinas lenkimas	● ● ● ● ● 1T	● ● ● ● ● 1T	● ● ● ○ ○ 2T	● ● ○ ○ ○ 3T
Techninė garantija	50 metų	40 metų	30 metų	30 metų
Estetinė garantija	25 metai	15 metų	10 metų	10 metų

\* Ruv5 ir RC5+ yra naujos, 2022 m. atnaujintuose standartuose EN 10169:2022 aprašytos, aukščiausios galimos atsparumo korozijai ir UV spinduliotei kategorijos. RC5+ ir Ruv5 kategorijas atitinkantys gaminiai turi būti išsamiai ištestuoti natūraliomis C5 poveikio aplinkos sąlygomis (ne laboratorijoje) ne trumpesni nei ketverių metų laikotarpį, bei išlikti atsparūs pūslių susidarymui, polimerinės dangos paviršiaus pažeidimams, briaunų lupimuisi daugiau nei 2 mm, maksimaliai ilgai išlaikyti spalvą ir blizgesį.

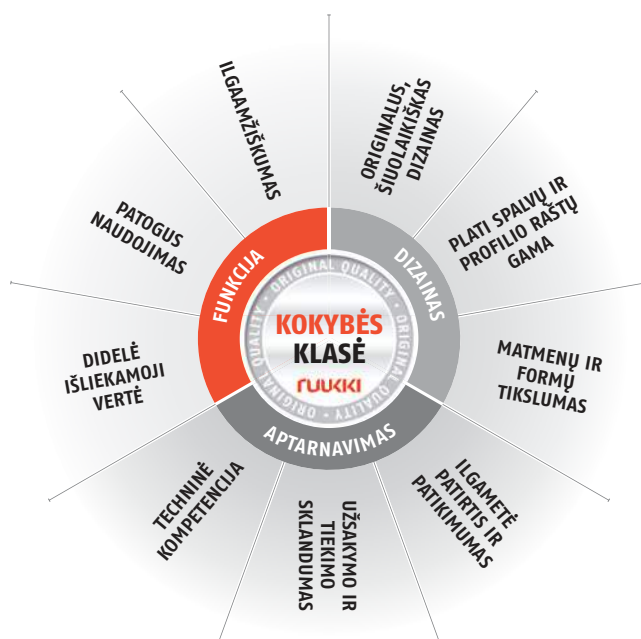

# Ruukki stogo dangų kainos

Kainos nurodytos už kvadratinį metrą

## Classic profiliai

Kaina €/m<sup>2</sup> su PVM 21% (€/m<sup>2</sup> be PVM)

Pavadinimas	Ruukki® 50 Plus Matt	Ruukki® 30 Plus Matt	Silence (su veltiniu) *
<b>Classic NextGen</b> SR35-475CF	<b>46,22</b> (38,20)		
<b>Classic Design C 271 mm</b> <b>NAUJIENA</b>	<b>38,96</b> (32,20)		
<b>Classic Design C 355 mm</b> <b>NAUJIENA</b>	<b>34,00</b> (28,10)		
<b>Classic Design C 475 mm</b> <b>NAUJIENA</b>	<b>31,58</b> (26,10)		
<b>Classic Authentic 0.6 mm</b> SR35-475C/D	<b>31,16</b> (25,75)		<b>37,11</b> (30,67)
<b>Classic M</b> SR35-475M	<b>26,26</b> (21,70)		<b>32,21</b> (26,62)
<b>Classic</b> SR35-475C/D	<b>25,65</b> (21,20)		<b>31,61</b> (26,12)
<b>Classic Economy Plus</b> SR35-475C/D		<b>16,46</b> (13,60)	<b>22,41</b> (18,52)

## Valcuoti lakštai

Kaina €/m<sup>2</sup> su PVM 21% (€/m<sup>2</sup> be PVM)

Pavadinimas	Ruukki® 50 Plus Matt	Ruukki® 30 Plus Matt	Ruukki® 30
<b>Valcuoti lakštai</b> SR27-543A/B	<b>22,51</b> (18,60)		

\* **Silence** – vidinėje Classic lakšto pusėje priklijuotas specialus, Dripstop Soundcontrol veltinis.

### Classic Silence privalumai

- Apie 40% geresnės akustinės savybės (-6dB)
- Degumo klasė B2 – s1, d0
- Sugeria iki 2500 g/m<sup>2</sup> kondensato

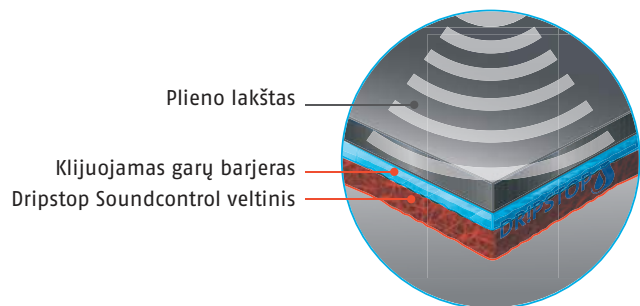
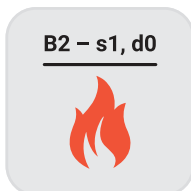



## Čerpiniai profiliai

Kaina €/m<sup>2</sup> su PVM 21% (€/m<sup>2</sup> be PVM)

Pavadinimas	Ruukki® 50 Plus Matt	Ruukki® 40	Ruukki® 30 Plus Matt	Ruukki® 30
<b>Adamante</b> TS55-350-1130	<b>23,35</b> (19,30)		<b>16,09</b> (13,30)	<b>14,76</b> (12,20)
<b>Monterrey FEB Forma®</b> TS44-350-1100	<b>21,72</b> (17,95)	<b>19,72</b> (16,30)		
<b>Monterrey</b> TS39-350-1100			<b>15,43</b> (12,75)	<b>13,49</b> (11,15)
<b>Monterrey Eco 0.45 mm</b> TS39-350-1100				<b>12,52</b> (10,35)

## Moduliniai profiliai

Kaina €/vnt. su PVM 21% (€/vnt. be PVM)

Pavadinimas	Ruukki® 50 Plus Matt	Ruukki® 40	Ruukki® 30 Plus Matt	Ruukki® 30
<b>Hyygge V*</b>		<b>10,95</b> (9,05)		
<b>Frigge**</b>	<b>19,66</b> (16,25)	<b>16,82</b> (13,90)	<b>16,34</b> (13,50)	<b>15,67</b> (12,95)
<b>Finnera***</b> TS52-330-1140		<b>14,35</b> (11,86)		

\* Hyygge 1 lakšto naudingas plotas yra 0,341 m<sup>2</sup>, kiekis paletėje – 180 vnt. Užsakoma pakuotėmis po 9 vienetus.

\*\* Frigge 1 lakšto naudingas plotas yra 0,83 m<sup>2</sup>, kiekis paletėje – 200 vnt. Už kiekį, mažesnę nei 60 vnt., taikomas startinis 30,25 (25,00) eurų startinis mokestis.

\*\*\* Finnera 1 lakšto naudingas plotas yra 0,75 m<sup>2</sup>, kiekis paletėje – 310 vnt.

Montuojant Ruukki 50, Ruukki 30 Plus ir Ruukki 30 kokybės klasių modulinius lakštus – nerekomenduojama naudoti skirtingų partijų gaminius.

## Profiliuoti lakštai

Kaina €/m<sup>2</sup> su PVM 21% (€/m<sup>2</sup> be PVM)

Pavadinimas	Ruukki® 50 Plus Matt	Ruukki® 40	Ruukki® 30 Plus Matt	Ruukki® 30
<b>T20</b> T20-24W-1100	<b>21,18</b> (17,50)	<b>18,39</b> (15,20)	<b>14,40</b> (11,90)	<b>13,07</b> (10,80)
<b>T20 su antikondensaciniu veltiniu ****</b> T20-24W-1100	<b>27,13</b> (22,42)	<b>24,34</b> (20,12)	<b>20,35</b> (16,82)	<b>19,02</b> (15,72)

Profilių užsakymams mažesniems nei 20 m<sup>2</sup> taikomas 36,30 (30,00) eurų startinis mokestis.

Profiliams, ilgesniems nei 6 tiesiniai metrai, reikalingas medinis padėklas. Padėklo kaina – 12,10 (10,00) eurai už tiesinį metrą.

Visą profiliuotų (trapecinių) lakštų asortimentą žr. 40–41 psl.

**\*\*\*\* Antikondensacinis sluoksnis** – vidinėje T20, T45 lakštų pusėje priklijuotas specialus, Dripstop Original veltinis.

### DripStop privalumai

- Geresnės akustinės savybės (-2dB)
- Degumo klasė A2 - s1, d0
- Sugeria iki 1000 g/m<sup>2</sup> kondensato

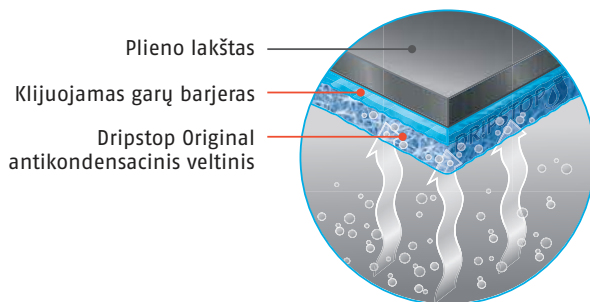
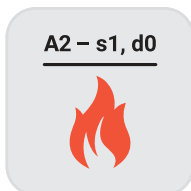

## Classic profiliai

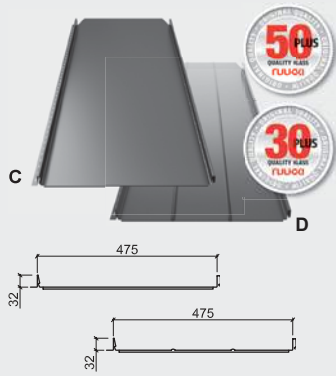

### CLASSIC C, D \*\*

Profilio aukštis	32 mm
Naudingas dengiamas plotis	475 mm
Bendras plotis	510 mm
Maksimalus naudingas ilgis	12 500 mm
Minimalus naudingas ilgis	1 200 mm
Minimalus stogo nuolydis	7°*
Lakšto storis	0.50 mm
Cinko kiekis	275 g/m <sup>2</sup>
Svoris	5.2 kg/m <sup>2</sup>

- ✓ Galimybė užsakyti Silence versiją
- ✓ Priekinio krašto užlenkimas
- ✓ Uždengiami valcų galai
- ✓ Mikroprofiluota tvirtinimo linija
- ✓ Bet kuri montavimo kryptis

\*\* Classic Economy Plus C/D – Ruukki 30 Plus kokybės klasės

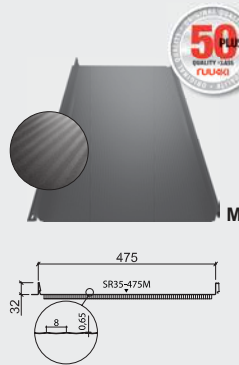

### CLASSIC M

Profilio aukštis	32 mm
Naudingas plotis	475 mm
Bendras plotis	510 mm
Maksimalus naudingas ilgis	12 500 mm
Minimalus naudingas ilgis	1 200 mm
Min. stogo nuolydis	7°*
Lakšto storis	0.50 mm
Cinko kiekis	275 g/m <sup>2</sup>
Svoris	5.2 kg/m <sup>2</sup>

- ✓ Galimybė užsakyti Silence versiją
- ✓ Priekinio krašto užlenkimas
- ✓ Uždengiami valcų galai
- ✓ Mikroprofiluota tvirtinimo linija
- ✓ Mikroprofiluotas lakštas
- ✓ Bet kuri montavimo kryptis

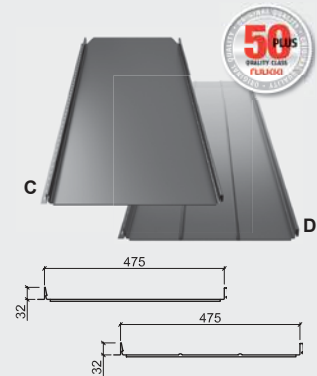

### CLASSIC AUTHENTIC C, D

Profilio aukštis	32 mm
Naudingas dengiamas plotis	475 mm
Bendras plotis	510 mm
Maksimalus naudingas ilgis	12 500 mm
Minimalus naudingas ilgis	1 200 mm
Minimalus stogo nuolydis	7°*
Lakšto storis	0.60 mm
Cinko kiekis	275 g/m <sup>2</sup>
Svoris	6.2 kg/m <sup>2</sup>

- ✓ Galimybė užsakyti Silence versiją
- ✓ Priekinio krašto užlenkimas
- ✓ Uždengiami valcų galai
- ✓ Mikroprofiluota tvirtinimo linija
- ✓ Bet kuri montavimo kryptis

## Valcuoti lakštai



### CLASSIC NEXTGEN

Profilio aukštis	33 mm
Naudingas dengiamas plotis	475 mm
Bendras plotis	510 mm
Maksimalus naudingas ilgis	12 500 mm
Minimalus naudingas ilgis	800 mm
Minimalus stogo nuolydis	7°*
Lakšto storis	0.60 mm
Cinko kiekis	275 g/m <sup>2</sup>
Svoris	6.4 kg/m <sup>2</sup>

- ✓ Sujungimų sandarumą ir akustines savybes pagerinanti valco tarpinė
- ✓ Akustinis/antikondensacinis veltinis
- ✓ Uždengiami valcų galai
- ✓ Priekinio krašto užlenkimas
- ✓ Mikroprofiluota tvirtinimo linija

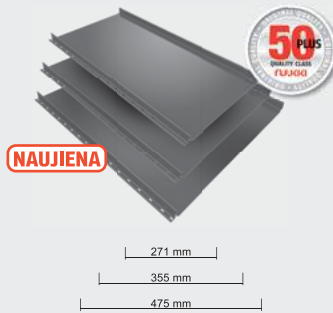

### CLASSIC DESIGN C 271/355/475 mm

Profilio aukštis	32 mm
Naudingas dengiamas plotis	475 mm, 355 mm, 271 mm
Bendras plotis	510 mm, 390 mm, 300 mm
Maksimalus ilgis	10 000 mm
Minimalus ilgis	1 200 mm
Minimalus stogo nuolydis	7°*
Lakšto storis	0.60 mm
Cinko kiekis	275 g/m <sup>2</sup>
Svoris	6.2, 6.7, 7.4 kg/m <sup>2</sup>

- ✓ Priekinio krašto užlenkimas, uždengiami valcų galai, mikroprofiluota tvirtinimo linija
- ✓ Naujiena: Neribotos raštų pasirinkimo galimybės derinant 3 pločius ir 3 spalvas



### VALCUOTI LAKŠTAI

Profilio aukštis	27 mm
Naudingas dengiamas plotis	543 mm
Maksimalus naudingas ilgis	10 000 mm
Minimalus naudingas ilgis	1 100 mm
Minimalus stogo nuolydis	7°
Lakšto storis	0.50 mm
Cinko kiekis	275 g/m <sup>2</sup>
Svoris	4.5 kg/m <sup>2</sup>



Pasirinkus Classic Silence (su veltiniu):

- apie 40% geresnės akustinės savybės (-6dB)
- mažiau kondensato
- gamyklinis, patikimas sprendimas

\* 7° nuolydis galioja, kai lakštai nejungiami į ilgį. Jei lakštai jungiami, minimalus nuolydis 14°.

Bendrą Classic profilių savybių palyginimo lentelę žiūrėti 39 psl.



## Čerpiniai profiliai

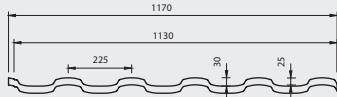

### ADAMANTE

Profilio aukštis	55 mm
Bangos ilgis	350 mm
Naudingas dengiamas plotis	1130 mm
Bendras plotis	1170 mm
Maksimalus ilgis	8 200 mm
Minimalus ilgis	800 mm
Minimalus stogo nuolydis	14°
Lakšto storis	0.50 mm
Cinko kiekis	275 g/m <sup>2</sup>
Svoris	4.8 kg/m <sup>2</sup>

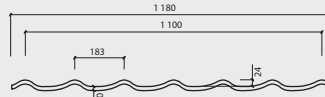

### MONTERREY FEB FORMA®

Profilio aukštis	44 mm
Bangos ilgis	350 mm
Naudingas dengiamas plotis	1100 mm
Bendras plotis	1180 mm
Maksimalus ilgis	8 000 mm
Minimalus ilgis	800 mm
Minimalus stogo nuolydis	14°
Lakšto storis	0.50 mm
Cinko kiekis	275 g/m <sup>2</sup>
Svoris	4.7 kg/m <sup>2</sup>

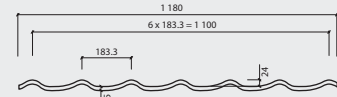

### MONTERREY ECO, MONTERREY

Profilio aukštis	39 mm
Bangos ilgis	350 mm
Naudingas dengiamas plotis	1100 mm
Bendras plotis	1180 mm
Maksimalus ilgis	8 000 mm
Minimalus ilgis	800 mm
Minimalus stogo nuolydis	14°
Lakšto storis	0.45, 0.50 mm
Cinko kiekis	275 g/m <sup>2</sup>
Svoris	4.1, 4.5 kg/m <sup>2</sup>

Ruukki Monterrey FEB forma® užlenktas kraštas – gražesnė forma, korozijai atsparesnis, ilgaamžiškesnis stogas.



## Moduliniai profiliai

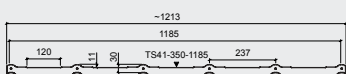

### FRIGGE

Profilio aukštis	41 mm
Bangos ilgis	350 mm
Naudingas plotis	1185 mm
Bendras plotis	1 213 mm
Naudingas ilgis	700 mm
Bendras ilgis	720 mm
Min. stogo nuolydis	14°
Lakšto storis	0.50 mm
Cinko kiekis	275 g/m <sup>2</sup>
Svoris	4.3 kg/m <sup>2</sup>
Lakšto svoris	3.5 kg/vnt.

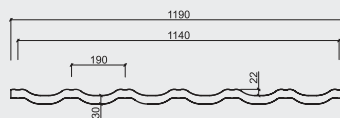

### FINNERA

Profilio aukštis	52 mm
Bangos ilgis	330 mm
Naudingas dengiamas plotis	1140 mm
Bendras plotis	1190 mm
Naudingas ilgis	660 mm
Bendras ilgis	708 mm
Minimalus stogo nuolydis	14°
Lakšto storis	0.50 mm
Cinko kiekis	275 g/m <sup>2</sup>
Svoris	5.0 kg/m <sup>2</sup>
Vieno lakšto svoris	3.8 kg/vnt.

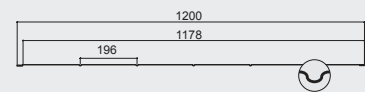
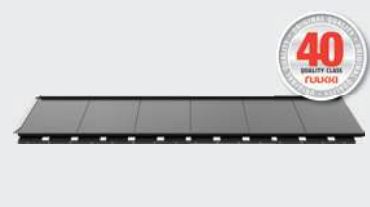

### HYYGGE V

Profilio aukštis	26 mm
Bangos ilgis	290 mm
Naudingas dengiamas plotis	1178 mm
Bendras plotis	1 200 mm
Naudingas ilgis	290 mm
Bendras ilgis	343 mm
Minimalus stogo nuolydis	14°
Lakšto storis	0.60 mm
Cinko kiekis	275 g/m <sup>2</sup>
Svoris	7.0 kg/m <sup>2</sup>
Vieno lakšto svoris	2.35 kg/vnt.

Profiliuotų (trapecinių) lakštų stogams ir sienoms duomenis žr. 35 psl.

# Ruukki padengimų spalvos

	Kokybės klasė 	Paviršius	Raudonos plytos RR 750	Raudona RR 29	Šokoladinė RR 887	Tamsi ruda RR 32	Tamsi žalia RR 11	Šviesi pilka RR 21	Pilka RR 22	Tamsi pilka RR 23	Antracito RR2H3	Juoda RR 33
--	--	-----------	---------------------------	------------------	----------------------	---------------------	----------------------	-----------------------	----------------	----------------------	--------------------	----------------

## Classic profiliai

Classic NextGen	Ruukki® 50 Plus	matinis	•	•		•	•	•	•	•	•	•
Classic Design C	Ruukki® 50 Plus	matinis								•	•	•
Classic Authentic	Ruukki® 50 Plus	matinis				•				•	•	•
Classic M	Ruukki® 50 Plus	matinis	•	•	•	•	•		•	•	•	•
Classic	Ruukki® 50 Plus	matinis	•	•	•	•	•		•	•	•	•
Classic Economy Plus	Ruukki® 30 Plus	matinis		•	•	•				•	•	•

## Valcuoti lakštai

Valcuoti lakštai	Ruukki® 50 Plus	matinis	•	•	•	•	•		•	•	•	•
------------------	-----------------	---------	---	---	---	---	---	--	---	---	---	---

## Čerpiniai profiliai

Adamante	Ruukki® 50 Plus	matinis	•	•	•	•	•			•	•	•
Adamante	Ruukki® 30 Plus	matinis		•	•	•				•	•	•
Adamante	Ruukki® 30	blizgus	•	•	•	•	•			•	•	•
Monterrey FEB forma®	Ruukki® 50 Plus	matinis	•	•	•	•	•			•	•	•
Monterrey FEB forma®	Ruukki® 40	pusiau matinis		•	•	•				•	•	•
Monterrey	Ruukki® 30 Plus	matinis		•	•	•				•	•	•
Monterrey	Ruukki® 30	blizgus	•	•	•	•	•			•	•	•
Monterrey Eco	Ruukki® 30	blizgus				•				•		

## Moduliniai lakštai

Hyygge V	Ruukki® 40	pusiau matinis								•	•	•
Frigge	Ruukki® 50 Plus	matinis	•	•	•	•				•	•	•
Frigge	Ruukki® 40	pusiau matinis	•	•	•	•				•	•	•
Frigge	Ruukki® 30 Plus	matinis	•	•	•	•				•	•	•
Frigge	Ruukki® 30	blizgus	•	•	•	•				•	•	•
Finnera	Ruukki® 40	pusiau matinis	•	•	•	•				•	•	•

## Profiliuoti lakštai

T20	Ruukki® 50 Plus	matinis	•	•	•	•	•	•	•	•	•	•
T20	Ruukki® 40	pusiau matinis		•	•	•				•	•	•
T20	Ruukki® 30	blizgus	•	•	•	•	•	•	•	•	•	•

\* Kitų spalvų ir padengimų kainų teirautis pas pardavėją.



## Standartiniai stogo lankstiniai Classic profiliams

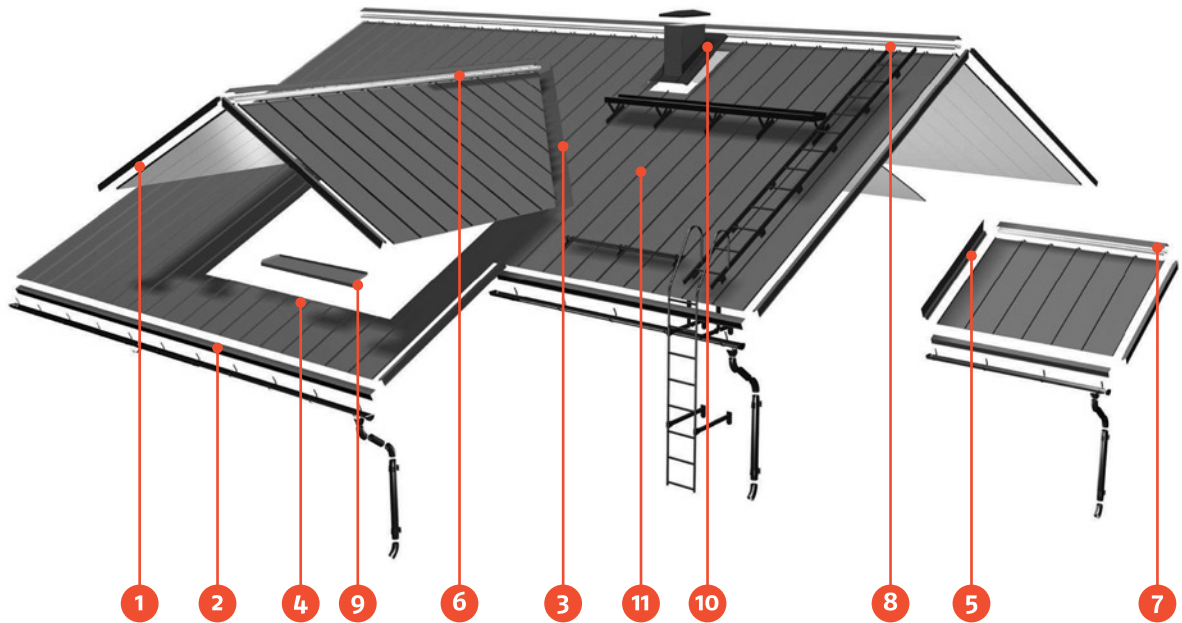









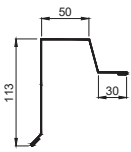

- 1 Vėjalentė
- 2 Karnizas
- 3 Apatinė sąlaja
- 4 Vidinis kampas

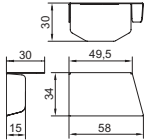
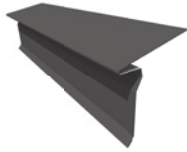
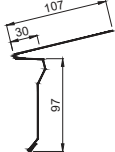
- 5 Šoninis jungimas prie sienos
- 6 Kraigas
- 7 Vienšlaitis kraigas
- 8 Kraigo vėdinimo detalė

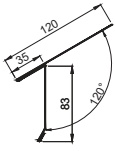
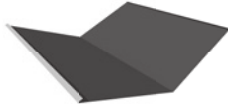
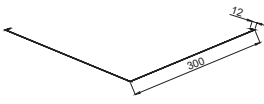
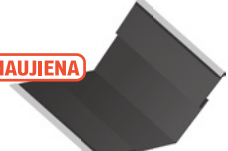
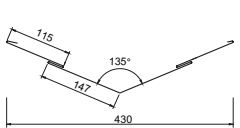
- 9 Palangės, angokraščiai
- 10 Kamino lankstiniai
- 11 Lakštų jungimo elementas

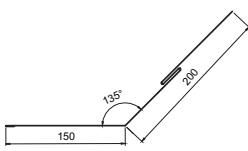

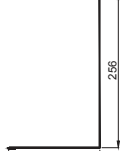
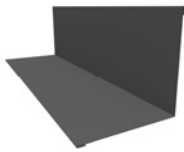
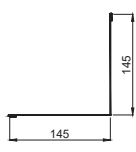

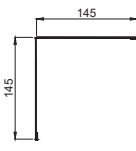



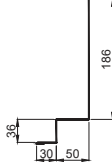

## Lankstiniai ir priedai

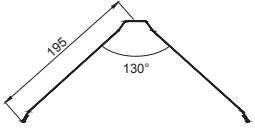
Kaina €/vnt. su PVM 21% (€/vnt. be PVM)

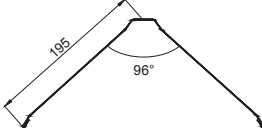
Vaizdas	Brėžinys	Pavadinimas	Kodas	Kokybės klasė	Kaina
		<b>Classic vėjalentė</b> L = 2000 mm	RA9AG	Ruukki® 50 Plus Matt Ruukki® 30 Plus Matt	<b>25,35</b> (20,95) <b>23,11</b> (19,10)
<b>NAUJIENA</b> 		<b>Classic vėjalentės antgalis</b> Komplektas (kairinis + dešininis)		Ruukki® 50 Plus Matt (Tik RR23, RR2H3, RR32 ir RR33 spalvos)	<b>7,86</b> (6,50)
		<b>Classic karnizo lenta</b> L = 2000 mm	RA9AEF	Ruukki® 50 Plus Matt	<b>20,33</b> (16,80)
		<b>Classic karnizo lenta</b> L = 2000 mm	RA1AE	Ruukki® 50 Plus Matt Ruukki® 30 Plus Matt	<b>20,33</b> (16,80) <b>17,55</b> (14,50)
		<b>Classic apatinė sąlaja 625</b> L = 2000 mm	625RA1BV	Ruukki® 50 Plus Matt Ruukki® 30 Plus Matt	<b>49,25</b> (40,70) <b>42,11</b> (34,80)
<b>NAUJIENA</b> 		<b>Classic apatinė sąlaja</b> L = 2000 mm	305000125	Ruukki® 50 Plus Matt Ruukki® 30 Plus Matt	<b>49,25</b> (40,70) <b>42,11</b> (34,80)
<b>NAUJIENA</b> 		<b>Classic šlaito sujungimas</b> L = 2000 mm	305000039	Ruukki® 50 Plus Matt Ruukki® 30 Plus Matt	<b>39,57</b> (32,70) <b>30,73</b> (25,40)
		<b>Vidinis kampas</b> L = 2000 mm	RA1BJ	Ruukki® 50 Plus Matt Ruukki® 30 Plus Matt	<b>39,57</b> (32,70) <b>30,73</b> (25,40)
		<b>Vidinis kampas</b> L = 2000 mm	RA1CI	Ruukki® 50 Plus Matt (išskyrus RR887) Ruukki® 30 Plus Matt (išskyrus RR887, RR2H3)	<b>26,56</b> (21,95) <b>25,35</b> (20,95)
		<b>Išorinis kampas</b> L = 2000 mm	RA1CE	Ruukki® 50 Plus Matt Ruukki® 30 Plus Matt (išskyrus RR887, RR2H3)	<b>26,56</b> (21,95) <b>25,35</b> (20,95)

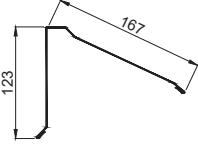
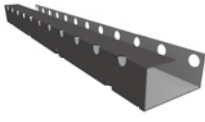
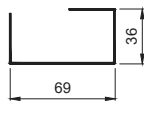
## Lankstiniai ir priedai

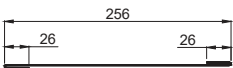
Kaina €/vnt. su PVM 21% (€/vnt. be PVM)

Vaizdas	Brėžinys	Pavadinimas	Kodas	Kokybės klasė	Kaina
		<b>Classic šoninis jungimas prie sienos</b> L = 2000 mm	RA1AJD	Ruukki® 50 Plus Matt Ruukki® 30 Plus Matt	<b>26,56</b> (21,95) <b>25,35</b> (20,95)
		<b>Classic kraigas</b> L = 2000 mm	RA9AR	Ruukki® 50 Plus Matt (išskyrus RR887, RR2H3) Ruukki® 30 Plus Matt	<b>25,35</b> (20,95) <b>23,11</b> (19,10)
		<b>Classic kraigas</b> L = 2000 mm	RA1AR	Ruukki® 50 Plus Matt (tik RR887, RR2H3) Ruukki® 30 Plus Matt	<b>25,35</b> (20,95) <b>23,11</b> (19,10)
		<b>Kraigas vienslaičiam stogui</b> L = 2000 mm	RA1AEU	Ruukki® 50 Plus Matt Ruukki® 30 Plus Matt	<b>28,31</b> (23,40) <b>27,77</b> (22,95)
		<b>Classic kraigo vėdinimo detalė</b>	RA1AS460 RA1AH3000	Ruukki® 50 Plus Matt L = 460 mm (pritaikyta Ruukki® Classic lakštams) Ruukki® 50 Plus Matt L = 3000 mm	<b>3,51</b> (2,90) <b>19,97</b> (16,50)
		<b>Sujungimo elementas</b> L = 440 mm	RA1ACJ	Paslėptas, Ruukki® 30, 0.60 mm	<b>7,02</b> (5,80)
		<b>Ventiliuojami plieniniai grebėstai</b> Ilgis – 3700 mm aukštis – 32 mm storis – 0,7 mm	RA545		<b>16,21</b> (13,40)



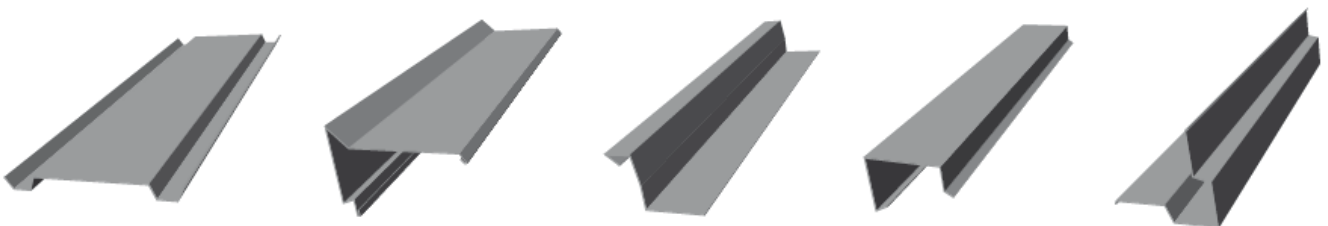



**Pagal užsakovo pateiktą brėžinį pagaminti nestandartiniai lankstiniai iki 8 m ilgio, palangės, angokraščiai bei sudėtingi kamino apdailos lankstiniai, įvairūs liukai ir kt.**



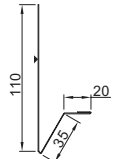

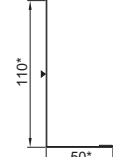
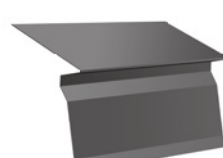
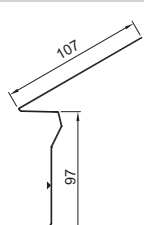
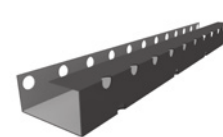
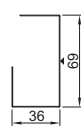
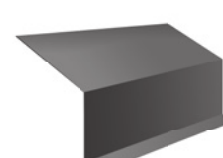
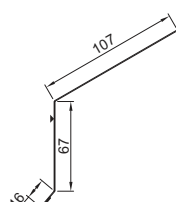

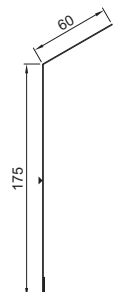

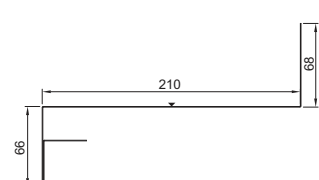
## Classic fasadų sprendiniams skirti lankstiniai

Kaina €/vnt. su PVM 21% (€/vnt. be PVM)

Vaizdas	Brėžinys	Pavadinimas	Kokybės klasė	Kaina
		<b>1. Pradžios lankstinys cokoliui</b>  L = 2400 mm	Paslėptas lankstinys, Ruukki 40, RR2H3, 0,50 mm	<b>27,65</b> (22,85)
		<b>2. Perforuotas lankstinys cokoliui</b>  * – matmuo pagal poreikį  L = 2400 mm  * – kaina galioja nurodytiems matmenims	Paslėptas lankstinys, Ruukki 40, RR2H3, 0,50 mm	<b>44,17</b> (36,50)
		<b>3. Reguliuojama karnizo lenta</b>  L = 2000 mm	Ruukki® 50 Plus matt 0,50 mm	<b>20,33</b> (16,80)
		<b>4. Ventiliuojamas kraigo elementas</b>  L = 460 mm L = 340 mm L = 255 mm	Ruukki® 50 Plus matt 0,60 mm	<b>3,51</b> (2,90) <b>3,03</b> (2,50) <b>2,54</b> (2,10)
		<b>5. Papildomas karnizo lankstinys</b>  L = 2000 mm	Ruukki® 50 Plus matt 0,50 mm	<b>20,33</b> (16,80)
		<b>6. Viršutinis kondensato nuvedimo lankstinys</b>  L = 2400 mm  Užsakomi su paslėpta lietaus sistema	Spalvos ir padengimai kaip paslėptos lietaus nuvedimo sistemos 0,50 mm	<b>14,64</b> (12,20)
		<b>7. Apatinis kondensato nuvedimo lankstinys</b>  L = 2400 mm  Užsakomi su paslėpta lietaus sistema	Spalvos ir padengimai kaip paslėptos lietaus nuvedimo sistemos 0,50 mm	<b>21,06</b> (17,55)

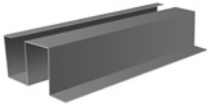
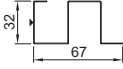
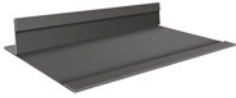
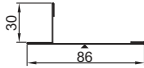

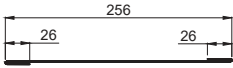
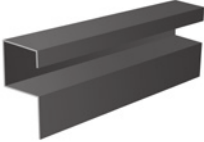
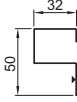
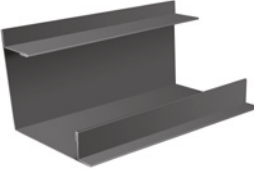
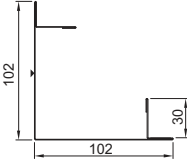
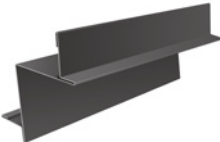
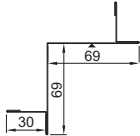

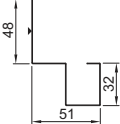



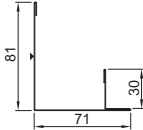
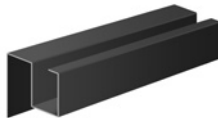
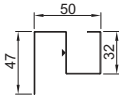

## Lankstiniai

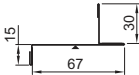
Kaina €/vnt. su PVM 21% (€/vnt. be PVM)

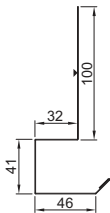
Vaizdas	Brėžinys	Pavadinimas	Kokybės klasė	Kaina
		<b>8. Atraminis fasadų sujungimo lankstinys</b> L = 2400 mm	Paslėptas lankstinys, Ruukki 40, RR2H3 0,50 mm	<b>28,19</b> (23,30)
		<b>9. Fasadų sujungimo apdailos lankstinys</b> L = 3000 mm	Ruukki® 50 Plus matt 0,50 mm	<b>28,19</b> (23,30)
		<b>10. Classic lakštų sujungimo lankstinys</b>	Paslėptas, Ruukki® 50, 0.50 mm L = 255 mm L = 340 mm	<b>5,81</b> (4,80) <b>6,05</b> (5,00)
		<b>11. Atraminis išorinio/vidinio kampo lankstinys</b> L = 2400 mm	Paslėptas lankstinys, Ruukki 40, RR2H3 0,50 mm	<b>20,45</b> (16,90)
		<b>12. Išorinio kampo apdailos lankstinys</b> L = 3000 mm	Ruukki® 50 Plus matt 0,50 mm	<b>60,32</b> (49,85)
		<b>13. Vidinio kampo apdailos lankstinys</b> L = 3000 mm	Ruukki® 50 Plus matt 0,50 mm	<b>48,04</b> (39,70)
		<b>14. Atraminis išorinio krašto lankstinys</b> L = 2400 mm	Paslėptas lankstinys, Ruukki 40, RR2H3 0,50 mm	<b>30,13</b> (24,90)

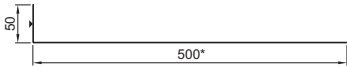
## Lankstiniai



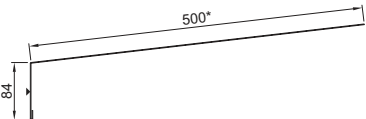







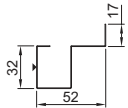

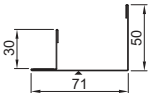
Kaina €/vnt. su PVM 21% (€/vnt. be PVM)

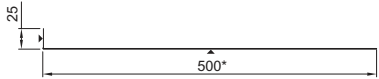
Vaizdas	Brėžinys	Pavadinimas	Kokybės klasė	Kaina
		<b>15. Išorinio krašto apdailos lankstinys</b> L = 3000 mm	Ruukki® 50 Plus matt 0,50 mm	<b>48,04</b> (39,70)
		<b>16. Atraminis vidinio krašto lankstinys</b> L = 2400 mm	Paslėptas lankstinys, Ruukki 40, RR2H3 0,50 mm	<b>30,13</b> (24,90)
		<b>17. Vidinio krašto apdailos lankstinys</b> L = 3000 mm	Ruukki® 50 Plus matt 0,50 mm	<b>32,07</b> (26,50)
		<b>18. Išorinis lango/durų viršaus lankstinys</b> L = 2400 mm	Ruukki® 50 Plus matt 0,50 mm	<b>41,99</b> (34,70)
		<b>19. Vidinis lango/durų viršaus lankstinys</b> * – matmuo pagal poreikį L = 2400 mm * – kaina galioja nurodytiems matmenims	Ruukki® 50 Plus matt 0,50 mm	<b>43,92</b> (36,30)
		<b>20. Apatinis palangės lankstinys (plati palangė)</b> L = 2400 mm	Paslėptas lankstinys, Ruukki 40, RR2H3 0,50 mm	<b>11,62</b> (9,60)
		<b>21. Palangės lankstinys (plati palangė)</b> * – matmuo pagal poreikį L = 2400 mm * – kaina galioja nurodytiems matmenims	Ruukki® 50 Plus matt 0,50 mm	<b>43,92</b> (36,30)

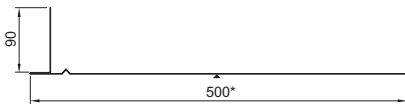

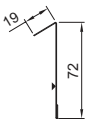
## Lankstiniai

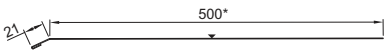
Kaina €/vnt. su PVM 21% (€/vnt. be PVM)

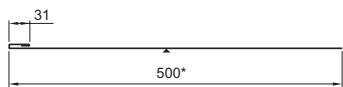
Vaizdas	Brėžinys	Pavadinimas	Kokybės klasė	Kaina
		<b>22. Atraminis lango/durų krašto lankstinys</b> L = 2400 mm	Paslėptas lankstinys, Ruukki 40, RR2H3 0,50 mm	<b>30,13</b> (24,90)
		<b>23. Lango/durų krašto apdailos lankstinys</b> L = 3000 mm	Ruukki® 50 Plus matt 0,50 mm	<b>41,99</b> (34,70)
		<b>24. Vidinis lango/durų krašto lankstinys</b> * – matmuo pagal poreikį L = 3000 mm * – kaina galioja nurodytiems matmenims	Ruukki® 50 Plus matt 0,50 mm	<b>49,55</b> (40,95)
		<b>25. Siauras lango/durų viršaus lankstinys</b> * – matmuo pagal poreikį L = 2400 mm * – kaina galioja nurodytiems matmenims	Ruukki® 50 Plus matt 0,50 mm	<b>57,54</b> (47,55)
		<b>26. Apatinis palangės lankstinys (siaura palangė)</b> L = 2400 mm	Ruukki® 50 Plus matt 0,50 mm	<b>17,42</b> (14,40)
		<b>27. Palangės lankstinys (siaura palangė)</b> * – matmuo pagal poreikį L = 2400 mm * – kaina galioja nurodytiems matmenims	Ruukki® 50 Plus matt 0,50 mm	<b>43,92</b> (36,30)
		<b>28. Siauras lango/durų krašto lankstinys</b> * – matmuo pagal poreikį L = 3000 mm * – kaina galioja nurodytiems matmenims	Ruukki® 50 Plus matt 0,50 mm	<b>49,55</b> (40,95)

## Standartiniai stogo lankstiniai čerpiniams ir profiliuotiems lakštams

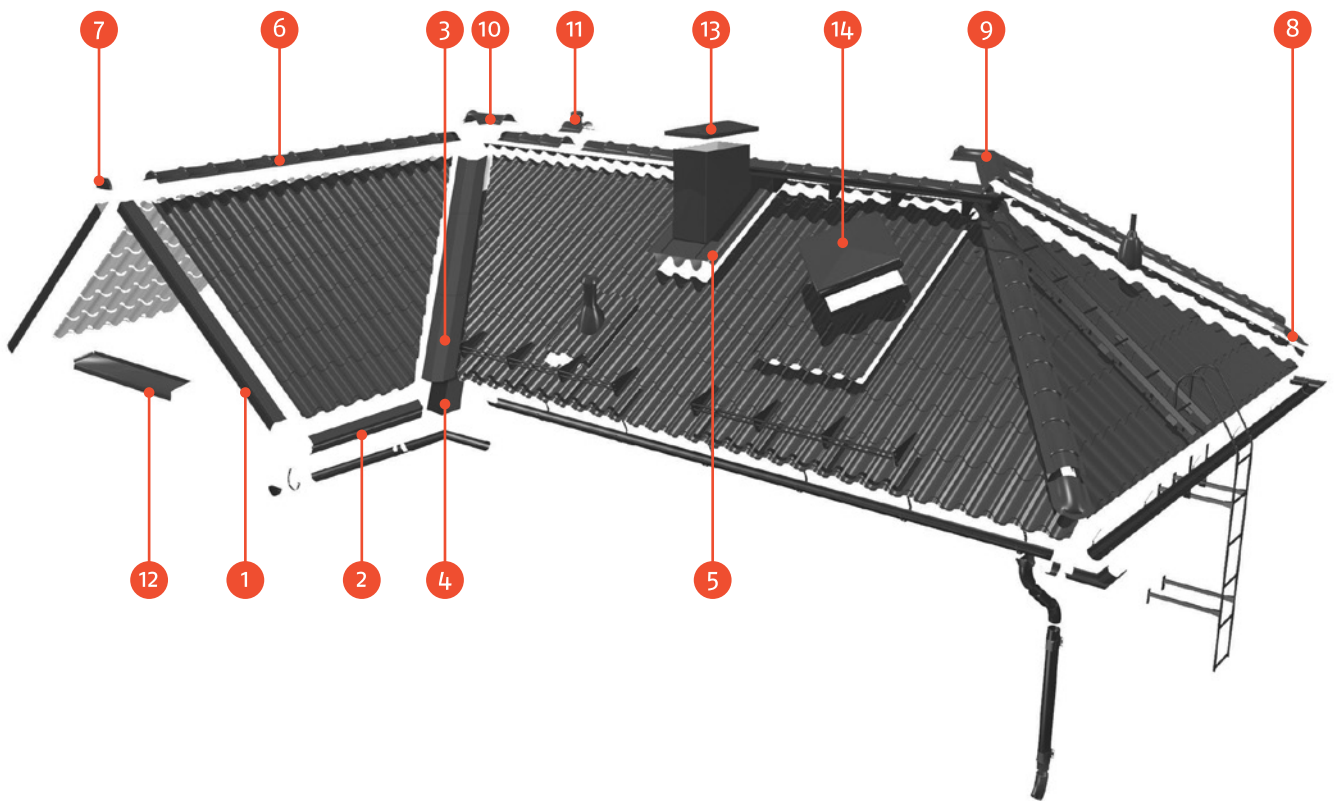

1 Vėjalentė

2 Karnizas

3 Sąlajos uždengimas

4 Apatinė sąlaja

5 Vidinis kampas

6 Kraigas

7 Kraigo dangtelis

8 Kraigo antgalis smailus

9 Y-formos kraigo jungtis

10 T-formos kraigo jungtis

11 Kaminėlis kraigo vėdinimui

12 Palangės, angokraščiai

13 Kamino lankstiniai

14 Sudėtingų formų lankstiniai, liukai

## Lankstiniai ir priedai







Kaina €/vnt. su PVM 21% (€/vnt. be PVM)

Vaizdas	Brėžinys	Pavadinimas	Kodas	Kokybės klasė	Kaina
		<b>Vėjalentė</b> Adamante Finnera Monterrey FEB Forma <sup>+</sup> T20 L = 2000 mm	RA9BG	Ruukki <sup>®</sup> 50 Plus Matt (išskyrus RR21, RR22, RR887, RR2H3)  Ruukki <sup>®</sup> 40 (išskyrus RR750, RR887, RR2H3)  Ruukki <sup>®</sup> 30 (išskyrus RR21, RR22, RR887, RR2H3)	<b>21,05</b> (17,40)  <b>19,00</b> (15,70)  <b>19,00</b> (15,70)
		<b>Vėjalentė</b> Adamante Finnera Monterrey FEB Forma <sup>+</sup> T20 L = 2000 mm	RA9BG-P	Ruukki <sup>®</sup> 50 Plus Matt (tik RR21, RR22, RR887, RR2H3)  Ruukki <sup>®</sup> 40 (tik RR750, RR887, R2H3)  Ruukki <sup>®</sup> 30 Plus Matt  Ruukki <sup>®</sup> 30 (tik RR21, RR22, RR887, RR2H3)	<b>21,05</b> (17,40)  <b>19,00</b> (15,70)  <b>19,00</b> (15,70)  <b>19,00</b> (15,70)
		<b>Vėjalentė Hygge</b> Hygge vėjalentė susideda iš 2 elementų. L = 2000 mm	30500HY310	Ruukki <sup>®</sup> 40	<b>27,10</b> (22,40)
		<b>Vėjalentė Frigge</b> Frigge vėjalentė susideda iš 2 elementų. L = 2000 mm	30500FR310	Ruukki <sup>®</sup> 50 Plus Matt  Ruukki <sup>®</sup> 40  Ruukki <sup>®</sup> 30 Plus Matt  Ruukki <sup>®</sup> 30	<b>31,82</b> (26,30)  <b>28,92</b> (23,90)  <b>28,92</b> (23,90)  <b>28,92</b> (23,90)
		<b>Vėjalentės apdaila (maža)</b> Hygge L = 2000 mm	195RA1BBC	Ruukki <sup>®</sup> 40	<b>14,28</b> (11,80)
		<b>Vėjalentės apdaila (didelė)</b> Hygge L = 2000 mm	260RA1BBC	Ruukki <sup>®</sup> 40	<b>16,82</b> (13,90)
		<b>Karnizas</b> Adamante Finnera Monterrey FEB Forma <sup>+</sup> T20 L = 2000 mm	130RA1BE	Ruukki <sup>®</sup> 50 Plus Matt (išskyrus RR22, RR750)  Ruukki <sup>®</sup> 40 (išskyrus RR750)  Ruukki <sup>®</sup> 30 Plus Matt  Ruukki <sup>®</sup> 30 (išskyrus RR33)	<b>20,33</b> (16,80)  <b>17,55</b> (14,50)  <b>17,55</b> (14,50)  <b>15,37</b> (12,70)
		<b>Karnizas</b> Adamante Finnera Monterrey FEB Forma <sup>+</sup> T20 L = 2000 mm	90RA1BE	Ruukki <sup>®</sup> 50 Plus Matt (tik RR21, RR22, RR887, RR2H3)  Ruukki <sup>®</sup> 40 (išskyrus RR750)  Ruukki <sup>®</sup> 30 Plus Matt  Ruukki <sup>®</sup> 30 (išskyrus RR33)	<b>20,33</b> (16,80)  <b>17,55</b> (14,50)  <b>17,55</b> (14,50)  <b>15,37</b> (12,70)

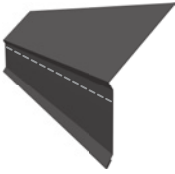
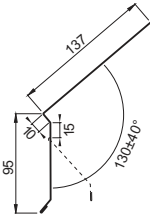

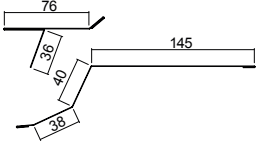

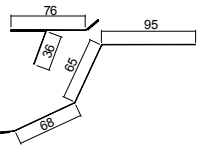
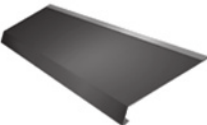
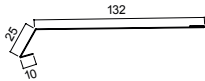
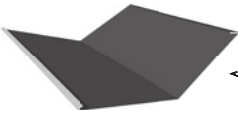
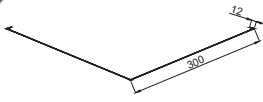
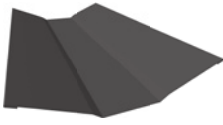
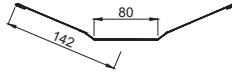
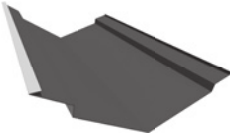
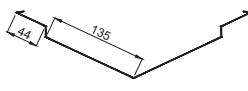

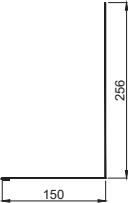



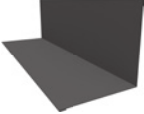
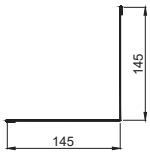

## Lankstiniai ir priedai

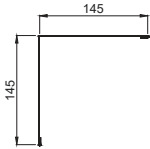
Kaina €/vnt. su PVM 21% (€/vnt. be PVM)

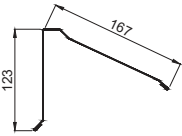
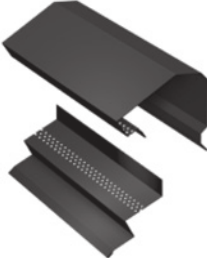
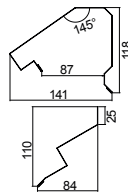
Vaizdas	Brėžinys	Pavadinimas	Kodas	Kokybės klasė	Kaina
		<b>Karnizas (perforuota linija kampo reguliavimui)</b>  Adamante Finnera Monterrey FEB Forma <sup>+</sup> T20  L = 2000 mm	RA9BEF	Ruukki <sup>®</sup> 50 Plus Matt	<b>20,33</b> (16,80)
				Ruukki <sup>®</sup> 40 (išskyrus RR887)	<b>17,55</b> (14,50)
				Ruukki <sup>®</sup> 30 (išskyrus RR22)	<b>15,37</b> (12,70)
		<b>Karnizas Hygge</b>  Hygge karnizas susideda iš 2 elementų.  L = 2000 mm		Ruukki <sup>®</sup> 40	<b>21,18</b> (17,50)
		<b>Karnizas Hygge (didelis)</b>  Hygge karnizas susideda iš 2 elementų.  L = 2000 mm	30500HY410	Ruukki <sup>®</sup> 40	<b>21,18</b> (17,50)
		<b>Karnizo lankstinys</b>  Hygge  L = 2000 mm	30500HY610	Ruukki <sup>®</sup> 40	<b>10,77</b> (8,90)
		<b>Apatinė sąlaja 625</b>  Adamante Finnera Monterrey FEB Forma <sup>+</sup> T20  L = 2000 mm	625RA1BV	Ruukki <sup>®</sup> 50 Plus Matt	<b>49,25</b> (40,70)
				Ruukki <sup>®</sup> 40	<b>42,11</b> (34,80)
				Ruukki <sup>®</sup> 30 Plus Matt	<b>42,11</b> (34,80)
				Ruukki <sup>®</sup> 30	<b>40,54</b> (33,50)
		<b>Sąlajos uždengimas</b>  Adamante Finnera Monterrey FEB Forma <sup>+</sup> T20  L = 2000 mm	RA1BVC	Ruukki <sup>®</sup> 50 Plus Matt	<b>25,47</b> (21,05)
				Ruukki <sup>®</sup> 40	<b>25,47</b> (21,05)
				Ruukki <sup>®</sup> 30 Plus Matt	<b>23,11</b> (19,10)
				Ruukki <sup>®</sup> 30	<b>21,05</b> (17,40)
		<b>Apatinė sąlaja Hygge</b>  L = 2000 mm	30500HY510	Ruukki <sup>®</sup> 40	<b>36,91</b> (30,50)
		<b>Vidinis kampas</b>  Adamante Finnera Monterrey FEB Forma <sup>+</sup> T20  L = 2000 mm	RA1BJ	Ruukki <sup>®</sup> 50 Plus Matt	<b>39,57</b> (32,70)
				Ruukki <sup>®</sup> 40	<b>30,73</b> (25,40)
				Ruukki <sup>®</sup> 30 Plus Matt	<b>30,73</b> (25,40)
				Ruukki <sup>®</sup> 30	<b>27,65</b> (22,85)

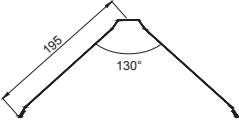
## Lankstiniai ir priedai

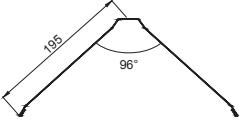
Kaina €/vnt. su PVM 21% (€/vnt. be PVM)

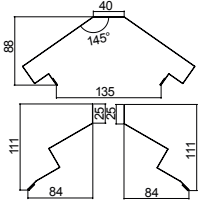
Vaizdas	Brėžinys	Pavadinimas	Kodas	Kokybės klasė	Kaina
		<b>Vidinis kampas</b> Adamante Finnera Monterrey FEB Forma <sup>+</sup> T20 L = 2000 mm	RA1CI	Ruukki <sup>+</sup> 50 Plus Matt Ruukki <sup>+</sup> 40 Ruukki <sup>+</sup> 30 Plus Matt Ruukki <sup>+</sup> 30	<b>26,56</b> (21,95) <b>25,35</b> (20,95) <b>25,35</b> (20,95) <b>24,40</b> (20,16)
		<b>Išorinis kampas</b> Adamante Finnera Monterrey FEB Forma <sup>+</sup> T20 L = 2000 mm	RA1CE	Ruukki <sup>+</sup> 50 Plus Matt Ruukki <sup>+</sup> 40 Ruukki <sup>+</sup> 30 Plus Matt Ruukki <sup>+</sup> 30	<b>26,56</b> (21,95) <b>25,35</b> (20,95) <b>25,35</b> (20,95) <b>24,40</b> (20,16)
		<b>Vienšlaičio stogo kraigas</b> Adamante Finnera Monterrey FEB Forma <sup>+</sup> T20 L = 2000 mm	RA1AEU	Ruukki <sup>+</sup> 50 Plus Matt Ruukki <sup>+</sup> 40 Ruukki <sup>+</sup> 30 Plus Matt Ruukki <sup>+</sup> 30	<b>28,31</b> (23,40) <b>27,77</b> (22,95) <b>27,77</b> (22,95) <b>25,17</b> (20,80)
		<b>Vienšlaičio stogo kraigas Hygge</b> Hygge vienšlaičio stogo kraigas susideda iš 2 elementų. L = 2000 mm	30500HY210	Ruukki <sup>+</sup> 40	<b>24,14</b> (19,95)
		<b>Lygus kraigas</b> Adamante Finnera Monterrey FEB Forma <sup>+</sup> T20 L = 2000 mm	RA9AR	Ruukki <sup>+</sup> 50 Plus Matt (išskyrus RR887, RR2H3) Ruukki <sup>+</sup> 40 (išskyrus RR750, RR887, RR2H3) Ruukki <sup>+</sup> 30 (išskyrus RR21, RR22, RR887, RR2H3)	<b>25,35</b> (20,95) <b>23,11</b> (19,10) <b>21,05</b> (17,40)
		<b>Lygus kraigas</b> Adamante Finnera Monterrey FEB Forma <sup>+</sup> T20 L = 2000 mm	RA1AR	Ruukki <sup>+</sup> 50 Plus Matt (tik RR887, RR2H3) Ruukki <sup>+</sup> 40 (tik RR750, RR887, RR2H3) Ruukki <sup>+</sup> 30 Plus Matt Ruukki <sup>+</sup> 30 (tik RR21, RR22, RR887, RR2H3)	<b>25,35</b> (20,95) <b>23,11</b> (19,10) <b>23,11</b> (19,10) <b>21,05</b> (17,40)
		<b>Hygge kraigas</b> Hygge kraigas susideda iš 3 elementų. L = 2000 mm	30500HY010	Ruukki <sup>+</sup> 40	<b>36,90</b> (30,50)



## Lankstiniai ir priedai

Kaina €/vnt. su PVM 21% (€/vnt. be PVM)

Vaizdas	Brėžinys	Pavadinimas	Kodas	Kokybės klasė	Kaina
		<b>Frigge kraigas</b> L = 2000 mm	30500FR010	Ruukki® 50 Plus Matt Ruukki® 40 Ruukki® 30 Plus Matt Ruukki® 30	<b>25,35</b> (20,95) <b>23,11</b> (19,10) <b>23,11</b> (19,10) <b>21,05</b> (17,40)
		<b>Frigge kraigas (mazas)</b> L = 2000 mm	30500FR020	Ruukki® 50 Plus Matt Ruukki® 40 Ruukki® 30 Plus Matt Ruukki® 30	<b>24,68</b> (20,40) <b>22,26</b> (18,40) <b>22,26</b> (18,40) <b>20,33</b> (16,80)
		<b>Apvalus kraigas</b> Adamante Finnera Monterrey FEB Forma® T20 L = 2100 mm	RA9BR0	Ruukki® 50 Plus Matt Ruukki® 40 Ruukki® 30 Plus Matt Ruukki® 30	<b>30,86</b> (25,50) <b>26,74</b> (22,10) <b>26,74</b> (22,10) <b>25,17</b> (20,80)
		<b>Kraigo antgalis smailus</b> Adamante Finnera Monterrey FEB Forma® T20	RA12H0	Plastikinis	<b>22,08</b> (18,25)
		<b>Kraigo dangtelis</b> Adamante Finnera Monterrey FEB Forma® T20	RA12E	Plastikinis	<b>4,72</b> (3,90)
		<b>Y-formos kraigo jungtis</b> Adamante Finnera Monterrey FEB Forma® T20	RA12Y0	Plastikinis	<b>48,28</b> (39,90)
		<b>T-formos kraigo jungtis</b> Adamante Finnera Monterrey FEB Forma® T20	RA12T	Plastikinis	<b>59,29</b> (49,00)
		<b>Kaminėlis kraigo vėdinimui</b> Adamante Finnera Monterrey FEB Forma® T20	RA12POP	Plastikinis	<b>72,60</b> (60,00)
		<b>Kaminėlis kraigo vėdinimui</b> Adamante Finnera Monterrey FEB Forma® T20	RA12PF	Plastikinis	<b>72,60</b> (60,00)

## Lankstiniai ir priedai

Kaina €/vnt. su PVM 21% (€/vnt. be PVM)

Vaizdas	Brėžinys	Pavadinimas	Kodas	Kokybės klasė	Kaina
		<b>Prie gegnių tvirtinamas kraigo tašelio laikiklis</b> Matmenys 40x210 mm Laikiklių skaičius bendroje pakuotėje 100 vnt.			vnt. <b>1,15</b> (0,95)
		<b>Reguliuojamas, prie gegnių tvirtinamas kraigo tašelio laikiklis</b> Matmenys 40x202 ÷ 225 mm Laikiklių skaičius bendroje pakuotėje 100 vnt.			vnt. <b>2,66</b> (2,20)
		<b>Ventiliuojami plieniniai grebėstai</b> Ilgis – 3700 mm aukštis – 32 mm storis – 0,7 mm			vnt. <b>16,21</b> (13,40)



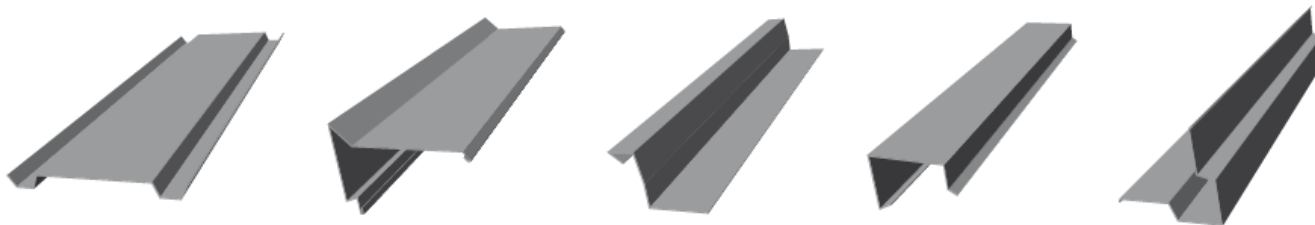



**Pagal užsakovo pateiktą brėžinį pagaminti nestandartiniai lankstiniai iki 8 m ilgio, palangės, angokraščiai bei sudėtingi kamino apdailos lankstiniai, įvairūs liukai ir kt.**



## Sraigčiai, plėvelės, dažai, tarpinės, sandarinimo juostos



### Sraigčiai

Kaina €/vnt. su PVM 21% (€/vnt. be PVM)

Vaizdas	Pavadinimas	Kodas	Pastabos	Mato vnt.	
	<b>Sraigčiai į medį</b> 4.8 x 28 mm	RAS1WD4828A14	100 vnt./pak., Spalvoti	pak.	<b>9,26</b> (7,65)
			100 vnt./pak., Zn	pak.	<b>8,71</b> (7,20)
	<b>Sraigčiai lakštų sujungimui</b> 4.8 x 20...23 mm	RAS1SL24820A14	100 vnt./pak., Spalvoti	pak.	<b>11,25</b> (9,30)
			100 vnt./pak., Zn	pak.	<b>9,20</b> (7,60)
	<b>Nerūdijančio plieno sraigčiai Classic tvirtinimui</b> 4.2 x 25 mm	RAS1WP4225PH2	100 vnt./pak., AiSi	pak.	<b>8,83</b> (7,30)
	<b>Nerūdijančio plieno sraigčiai Classic tvirtinimui</b> 4.2 x 25 mm	RAS1SP4225PH2	AiSi	vnt.	<b>0,19</b> (0,16)
	<b>Valcuoto profilio laikikliai L = 25</b>	696200000000	Plienas	vnt.	<b>0,097</b> (0,08)
		69620000000J	Nerūdyjantis plienas	vnt.	<b>0,278</b> (0,23)
		69621000000J	Paslankūs, nerūdyjantis plienas	vnt.	<b>0,557</b> (0,46)
	<b>Ruukki LP™ Torx sraigčiai</b> Universalus – tinka ir į medį, ir lakštų sujungimui 4.8 x 28 mm	S1T48028WA4RR	100 vnt./pak., Spalvoti	pak.	<b>13,92</b> (11,50)
	<b>Magnetinė galvutė Ruukki LP™ Torx sraigčiams</b>		1 vnt. + 5 antgaliai	pak.	<b>17,24</b> (14,25)

### Plėvelės



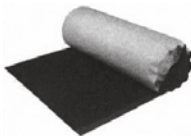
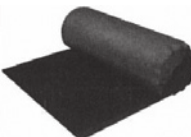







Kaina €/vnt. su PVM 21% (€/vnt. be PVM)

Vaizdas	Pavadinimas	Kodas	Pastabos	Plotis, kiekis rulone	
	<b>Difuzinė plėvelė (rulonais)</b> Kvėpuojanti, su dviem integruotomis lipniomis juostomis	Ruukki 175 FIX	175 g/m <sup>2</sup> , armuota, 4 sl.	1.5 m; 75 m <sup>2</sup>	<b>209,94</b> (173,50)
		Ruukki 175 FIX	175 g/m <sup>2</sup> , armuota, 4 sl.	1.5 m; 30 m <sup>2</sup>	<b>91,90</b> (75,95)
		Ruukki 145 FIX	145 g/m <sup>2</sup> , 3 sl.	1.5 m; 75 m <sup>2</sup>	<b>140,30</b> (115,95)
		Ruukki 145 FIX	145 g/m <sup>2</sup> , 3 sl.	1.5 m; 30 m <sup>2</sup>	<b>64,55</b> (53,35)
	<b>Antikondensacinė plėvelė (rulonais)</b> Nekvėpuojanti	Ruukki 50 Plus		1.5 m; 60 m <sup>2</sup>	<b>127,66</b> (105,50)
		Ruukki 50 Plus		1.5 m; 30 m <sup>2</sup>	<b>64,74</b> (53,50)
		Ruukki 30		1.5 m; 60 m <sup>2</sup>	<b>58,69</b> (48,50)
	<b>Permo sec SK (rulonais)</b> Ventiliacinį tarpą užtikrinanti plėvelė, skirta valcuojamiems metaliniams stogams tvirtinti ant ištinio pakloto		550 g/m <sup>2</sup>	1.5 m; 37.5 m <sup>2</sup>	<b>477,95</b> (395,00)
	<b>Permo sec 400 SK (rulonais)</b> Ventiliacinį tarpą užtikrinanti plėvelė, skirta valcuojamiems metaliniams stogams tvirtinti ant ištinio pakloto		400 g/m <sup>2</sup>	1.5 m; 37.5 m <sup>2</sup>	<b>366,63</b> (303,00)

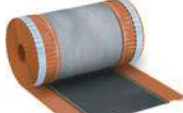

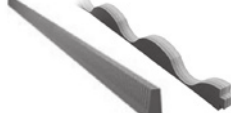
## Sandarinimo juostos ir tarpinės

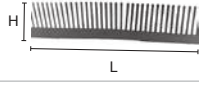
Kaina €/vnt. su PVM 21% (€/vnt. be PVM)

Vaizdas	Pavadinimas	Kodas	Plotis, kiekis rulone	Mato vnt.	
	<b>Ruukki A+</b> vienpusio lipnumo skaidri juosta	650K	50 mm x 25 m	rul.	<b>28,44</b> (23,50)
	<b>Klüber Tacto</b> dvipusio lipnumo sandarinimo juosta	65063	20 mm x 50 m	rul.	<b>23,17</b> (19,15)
	<b>ABSORBER</b> ventiliuojamo tašelio sandarinimo juosta Klüber KU0079-1-50	6401C	50mm x 30m	rul.	<b>41,50</b> (34,30)
	<b>Permo Seal</b> ventiliuojamo tašelio sandarinimo putos	69J13		1000 g	<b>34,24</b> (28,30)
	<b>Ruukki FLEXO</b> kamino sandarinimo juosta (pilka, raudona, ruda, juoda)	69J09	300 mm x 5 m	rul.	<b>29,22</b> (24,15)
	<b>Ruukki ROOL SUPER</b> (pilka, raudona, ruda, juoda)	69J07	310 mm x 5 m	rul.	<b>19,00</b> (15,70)
	<b>EASY-FORM®</b> universali tampri sandarinimo juosta, aliuminuota	69J16	90mm x 10m	rul.	<b>59,29</b> (49,00)
	<b>Universali tarpinė</b>	RA3FUNI50	H = 50 mm	m	<b>1,75</b> (1,45)
		RA3FUNI30	H = 60 mm	m	<b>2,12</b> (1,75)
	<b>Tarpinė Adamante</b>	RA3FR55350B	L = 1 125 mm	vnt.	<b>1,75</b> (1,45)
	<b>Tarpinė Monterrey</b>	RA3FR39350B	L = 1 100 mm	vnt.	<b>1,75</b> (1,45)
	<b>Tarpinė Finnera</b>	RA3FR52330B	L = 1 140 mm	vnt.	<b>1,75</b> (1,45)
	<b>Tarpinė T20 (didelė)</b>	RA3FR2024B	L = 1 100 mm	vnt.	<b>1,75</b> (1,45)
	<b>Tarpinė T45 (didelė)</b>	RA3FR4528B	L = 900 mm	vnt.	<b>2,12</b> (1,75)
	<b>Akustinė tarpinė Classic</b>	RA3ASIB	25 m rulonas	rul.	<b>25,53</b> (21,10)
			50 m rulonas	rul.	<b>47,80</b> (39,50)
	<b>Vienpusio lipnumo akustinė Classic juosta</b>	6402C	100 mm x 5 mm x 20 m	rul.	<b>21,24</b> (17,55)
	<b>Užtvara nuo paukščių čerpiniams profiliais</b> RR23, RR32, RR33	RA4VG	L = 1 000 mm H = 60 mm	vnt.	<b>1,45</b> (1,20)
	<b>Sandarinimo mastika skaidri drėgniems paviršiams</b>	69J07	280 ml	vnt.	<b>12,71</b> (10,50)

## Dažai, kaminėliai ir įvadai







### Dažai

Kaina €/vnt. su PVM 21% (€/vnt. be PVM)

Vaizdas	Pavadinimas	Kodas	Pastabos	
	<b>Dažai</b>	RA6RP0024	24 ml	<b>8,11</b> (6,70)
	<b>Dažai matiniai</b>	RA6RP0024M	24 ml	<b>9,14</b> (7,70)
	<b>Dažai</b>	RA6RP01	100 ml	<b>15,25</b> (12,60)

### Kaminėliai

Kaina €/vnt. su PVM 21% (€/vnt. be PVM)

Vaizdas	Pavadinimas	Kodas	Pastabos		
	<b>Kaminėlis su elektriniu ventiliatorium</b>	67305	160 mm ø	E220P	<b>462,22</b> (382,00)
		67037	125 mm ø	E190P	<b>431,97</b> (357,00)
	<b>Neapšiltintas alsuoklis FLOW su gaubtu</b>	67325	110 mm ø	h=300 mm	<b>38,11</b> (31,50)
	<b>Apšiltintas alsuoklis FLOW su gaubtu</b>	67324	110 mm ø	h=350 mm	<b>68,12</b> (56,30)
	<b>Pritekėjimo elementas 160/IS/500</b>	67131	160 mm ø	h=500 mm	<b>234,74</b> (194,00)
	<b>Kaminėlis FLOW 125</b>	67333	125 mm ø	h=500 mm	<b>98,86</b> (81,70)
	<b>Kaminėlis FLOW 160</b>	67326	160 mm ø	h=500 mm	<b>159,11</b> (131,50)

Kaminėlių, kaminėlių pagrindų ir Solar praėjimų spalvos

Raudonos plytos  
(RR750)

Raudona  
(RR29)

Tamsi ruda  
(RR32)

Žalia  
(RR11)

Tamsi pilka  
(RR23)

Juoda  
(RR33)

## Kaminėlių pagrindai

Kaina €/vnt. su PVM 21% (€/vnt. be PVM)

Vaizdas	Pavadinimas	Kodas	Pastabos	
	Kaminėlio pagrindas Classic (nuolydis 11,5-57 laipsniai)	67116	VINO, Ø 75-160 mm	<b>40,05</b> (33,10)
	Kaminėlio pagrindas Classic (nuolydis 5-27 laipsniai)		LOIVA, Ø 75-160 mm	<b>51,30</b> (42,40)
	Kaminėlio pagrindas Adamante	67096a		<b>57,11</b> (47,20)
	Kaminėlio pagrindas Monterrey	67096		<b>49,25</b> (40,70)
	Kaminėlio pagrindas Frigge	6725K		<b>65,10</b> (53,80)
	Kaminėlio pagrindas Finnera	67096T	Nera	<b>57,11</b> (47,20)
	Universalus kaminėlio pagrindas	67097	Pelti	<b>68,85</b> (56,90)
	Kaminėlio pagrindas Hyygge	6725H		<b>57,11</b> (47,20)
	Vilpe 2K hidroizoliacinis sandariklis	64M11		<b>23,41</b> (19,35)

## Įvada ir Solar praėjimai

Kaina €/vnt. su PVM 21% (€/vnt. be PVM)

Vaizdas	Pavadinimas	Kodas	Pastabos	
	Įvado lizdas	67100	12-102 mm	<b>27,28</b> (22,55)
	Įvado lizdas	67099	121-254 mm	<b>40,89</b> (33,79)
	Vamzdžio praėjimas 110-155 Juodas	67244	110-155 mm Ø	<b>43,32</b> (35,80)
	Solar praėjimas Classic	67M12		<b>86,76</b> (71,70)
	Solar praėjimas čerpiams profiliams	67M10		<b>94,38</b> (78,00)
	Solar universalus praėjimas			<b>142,05</b> (117,40)
	Solar praėjimų kabelių sandariklis Juodas			<b>18,76</b> (15,50)

## Standartinė apvali lietaus vandens nuvedimo sistema



**MONTAVIMO IR NAUDOJIMO INSTRUKCIJA**





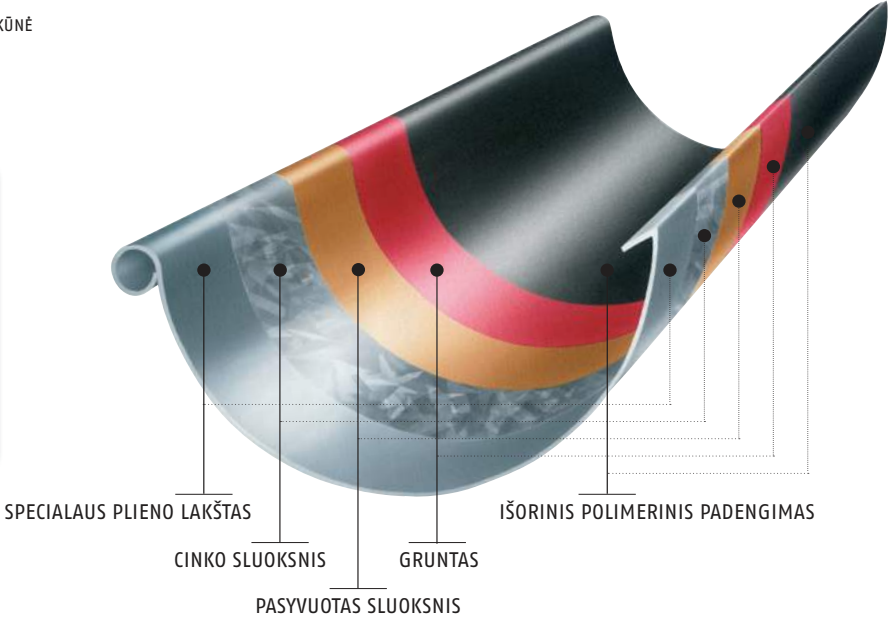
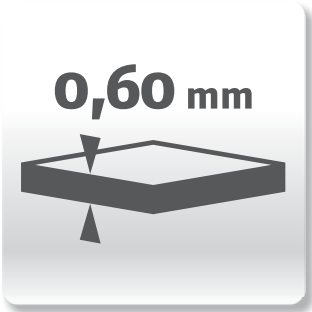







**YouTube**

[www.ruukki.lt/r](http://www.ruukki.lt/r)



## Latai ir priedai











Kaina €/vnt. su PVM 21% (€/vnt. be PVM)

Vaizdas	Pavadinimas	Plotis	Kodas	Pastabos	Standartinis padengimas (GreenCoat RWS)	Matinis padengimas (GreenCoat RWS PRO BT Matt)
	<b>101 Latakas</b>	125 mm	5513e00000A	3.0 m	<b>20,81</b> (17,20)	<b>22,69</b> (18,75)
		125 mm	5514e00000A	4.0 m	<b>27,71</b> (22,90)	<b>30,19</b> (24,95)
		150 mm	5513g00000A	3.0 m	<b>26,86</b> (22,20)	
		150 mm	5514g00000A	4.0 m	<b>35,27</b> (29,15)	
	<b>102 Vidinis kampas 90°</b>	125 mm	5521e00000A		<b>17,06</b> (14,10)	<b>18,63</b> (15,40)
		150 mm	5521g00000A		<b>19,12</b> (15,80)	
	<b>103 Išorinis kampas 90°</b>	125 mm	5522e00000A		<b>17,06</b> (14,10)	<b>18,63</b> (15,40)
		150 mm	5522g00000A		<b>19,12</b> (15,80)	
	<b>102-9 Vidinis kampas 135°</b>	125 mm	5523e00000A		<b>43,38</b> (35,85)	
		150 mm	5523g00000A		<b>44,53</b> (36,80)	
	<b>103-9 Išorinis kampas 135°</b>	125 mm	5524e00000A		<b>43,38</b> (35,85)	
		150 mm	5524g00000A		<b>44,53</b> (36,80)	
	<b>115 Latako galas COMBI</b>	125 mm	5547e00000A		<b>4,96</b> (4,10)	<b>5,46</b> (4,51)
		150 mm	5547g00000A		<b>7,02</b> (5,80)	
	<b>190 Reguliuojamas laikiklis</b>	125 mm	5551e00000A		<b>6,73</b> (5,55)	<b>7,32</b> (6,05)
		150 mm	5551g00000A		<b>10,16</b> (8,40)	
	<b>169 Kompaktiškas laikiklis</b>	125 mm	5559e00000A		<b>2,18</b> (1,80)	<b>2,40</b> (1,98)
		150 mm	5559g00000A		<b>3,09</b> (2,55)	
	<b>Latako laikiklis Strong 125</b>	125 mm	556Ae00000A		<b>5,45</b> (4,50)	
	<b>166 Ilgas tiesus laikiklis</b>	125 mm	5556e00000A	205 ilgas	<b>4,36</b> (3,60)	<b>4,78</b> (3,95)
	<b>168 Trumpas tiesus laikiklis</b>	125 mm	5558e00000A	55 trumpas	<b>3,51</b> (2,90)	<b>3,86</b> (3,19)
		150 mm	5556g00000A	210 ilgas	<b>4,48</b> (3,70)	
		150 mm	5558g00000A	55 trumpas	<b>3,75</b> (3,10)	
	<b>142 Latako sujungimo apkaba</b>	125 mm	5531e00000A		<b>4,96</b> (4,10)	<b>5,45</b> (4,50)
		150 mm	5531g00000A		<b>5,32</b> (4,40)	
	<b>Latako sujungimo apkaba (plati)</b>	125 mm	5535e000001		<b>7,38</b> (6,10)	<b>8,11</b> (6,70)





## Lietvamzdžiai ir priedai

Kaina €/vnt. su PVM 21% (€/vnt. be PVM)

Vaizdas	Pavadinimas	Plotis	Kodas	Pastabos	Standartinis padengimas (GreenCoat RWS)	Matinis padengimas (GreenCoat RWS PRO BT Matt)
	<b>220 Lietvamzdis</b>	90 mm	5611m00000A	1.0 m	<b>13,67</b> (11,30)	<b>15,00</b> (12,40)
		90 mm	5612m00000A	2.5 m	<b>23,41</b> (19,35)	<b>25,77</b> (21,30)
		90 mm	5614m00000A	4.0 m	<b>35,70</b> (29,50)	<b>39,26</b> (32,45)
		100 mm	5611000000A	1.0 m	<b>21,18</b> (17,50)	
		100 mm	5612000000A	2.5 m	<b>30,13</b> (24,90)	
		100 mm	5614000000A	4.0 m	<b>43,20</b> (35,70)	
	<b>112 Įlaja</b>	90 mm	5582m00000A		<b>11,01</b> (9,10)	<b>12,10</b> (10,00)
		100 mm	55832000000A		<b>16,36</b> (13,50)	
	<b>217 Viršutinė alkūnė</b>	90 mm	5632m00000A		<b>7,02</b> (5,80)	<b>7,72</b> (6,38)
		100 mm	56320000000A		<b>7,99</b> (6,60)	
	<b>226 Apatinė alkūnė</b>	90 mm	5641m00000A		<b>8,23</b> (6,80)	<b>9,05</b> (7,48)
		100 mm	56410000000A		<b>9,26</b> (7,65)	
	<b>221 Lietvamzdžio jungtis</b>	90 mm	5664m00000A		<b>4,90</b> (4,05)	<b>5,38</b> (4,45)
		100 mm	56640000000A		<b>5,26</b> (4,35)	
	<b>Lietvamzdžio laikiklis (pleištinis)</b>		5657m00000A	90 mm	<b>3,09</b> (2,55)	<b>3,39</b> (2,80)
			56520000000A	100 mm	<b>4,96</b> (4,10)	
	<b>245 Y-jungtis</b>	90 mm	5635m00000A		<b>52,51</b> (43,40)	<b>57,76</b> (47,74)
		100 mm	56350000000A		<b>53,60</b> (44,30)	
	<b>241 Vandens surinkėjas</b>	90 mm	5663m00000A		<b>63,89</b> (52,80)	
		100 mm	56630000000A		<b>67,64</b> (55,90)	
	<b>227 Įvadas į žemę</b>	90 mm	5662m00000A		<b>33,64</b> (27,80)	<b>36,91</b> (30,50)
		100 mm	56620000000A		<b>42,35</b> (35,00)	
	<b>457 Lietvamzdžio perėjimas lapų gaudyklei (plastikinis)</b>		58320000001	80-150	<b>5,46</b> (4,50)	

Kaina €/vnt. su PVM 21% (€/vnt. be PVM)

Vaizdas	Pavadinimas	Plotis	Kodas	Pastabos	Standartinis padengimas (GreenCoat RWS)	Matinis padengimas (GreenCoat RWS PRO BT Matt)
	458 Išsivalančioji lapų gaudyklė (plastikinė)		5834000000		25,05 (20,70)	
	117 Tiesusis apsaugas nuo pratekėjimo		5822000000		28,68 (23,70)	
	116 Kampinis apsaugas nuo pratekėjimo		5821000000		33,03 (27,30)	
	238 Piltuvas	90	5621m00000A		52,15 (43,10)	
		100	5621000000A		56,14 (46,40)	

#### Ruukki standartinės lietaus nuvedimo sistemos spalvos (GreenCoat RWS padengimas)

Raudonos plytos (RR750)	Raudona (RR29)	Šokoladinė (RR887)	Tamsi ruda (RR32)	Tamsi sidabrinė (RR41)	Balta (RR20)
Tamsi pilka (RR23)	Antracito (RR2H3)	Juoda (RR33)	Sidabro (RR40)		

#### Ruukki matinės lietaus nuvedimo sistemos spalvos (GreenCoat RWS PRO BT Matt padengimas)

Juoda (RR33)
--------------

## Siba Tech universali gilių latakų lietaus sistema

**NAUJIENA**

Siba Tech latakų sistema – tai sprendimas, kuriame naujoviška latakų forma sujungia pusapvalės ir kvadratinės sistemos privalumus. Sistema Siba Tech leidžia pasirinkti latakų priekį vienoje sistemoje, o tai taip pat reiškia, kad estetinį vaizdą galima priderinti prie kiekvieno namo.



### Siba Tech apvalipriekinė dalis

1. Latakas
2. Išorinis apvalus kampas
3. Vidinis apvalus kampas
4. Latakų sujungimo apkaba
5. Latakų galas
6. Laikiklis
7. Apvalus lietvamzdis
8. Apvalaus lietvamzdžio įlaja
9. Viršutinė alkūnė
10. Apatinė alkūnė
11. Lietvamzdžio laikiklis

**NAUJIENA**

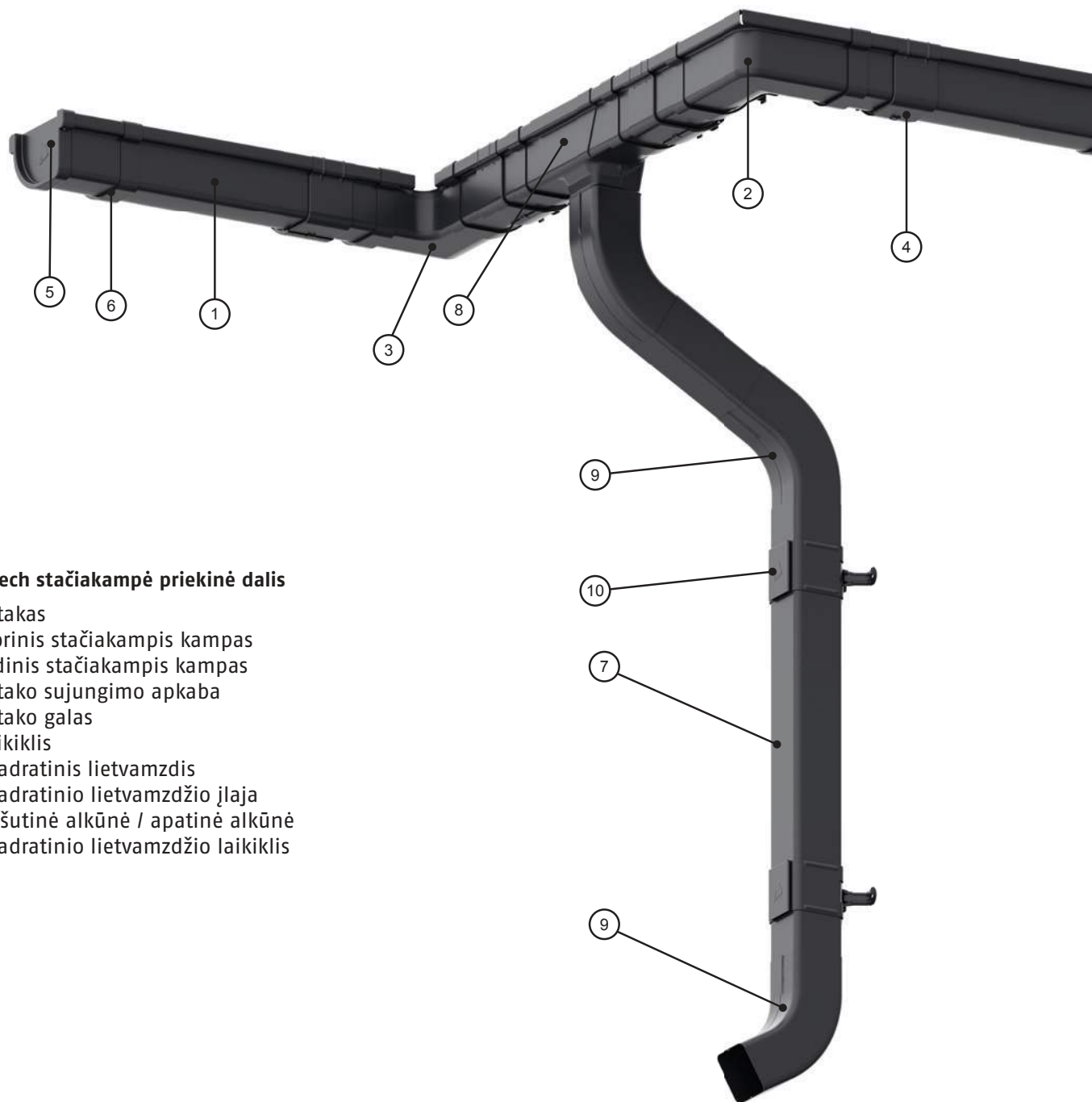

#### Siba Tech stačiakampė priekinė dalis













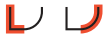

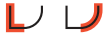



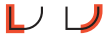



1. Latakas
2. Išorinis stačiakampis kampas
3. Vidinis stačiakampis kampas
4. Latako sujungimo apkaba
5. Latako galas
6. Laikiklis
7. Kvadratinis lietvamzdis
8. Kvadratinio lietvamzdžio įlaja
9. Viršutinė alkūnė / apatinė alkūnė
10. Kvadratinio lietvamzdžio laikiklis

Ruukki standartinės lietaus nuvedimo sistemos spalvos (GreenCoat RWS padengimas)

Šokoladinė (RR887)	Tamsi pilka (RR23)	Antracito (RR2H3)	Juoda (RR33)
-----------------------	-----------------------	----------------------	-----------------

**Siba Tech gilių latakų lietaus sistemos komponentai**



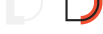





















Kaina €/vnt. su PVM 21% (€/vnt. be PVM)

Vaizdas	Pavadinimas	Dydis	Ilgis	Kiekis pakuotėje	Kaina su PVM
	<b>Latakas</b> 	140 mm	4000 mm	3	<b>38,12</b> (31,50)
		140 mm	3000 mm	3	<b>28,62</b> (23,65)
	<b>Vidinis stačiakampis / išorinis apvalus kampas</b> 	140 mm		15	<b>13,79</b> (11,40)
	<b>Išorinis stačiakampis / vidinis apvalus kampas</b> 	140 mm		15	<b>13,79</b> (11,40)
	<b>Latako sujungimo apkaba</b> 	140 mm		20	<b>7,38</b> (6,10)
	<b>Kairinis stačiakampis / dešininis apvalus latakų galas</b> 	140 mm		50	<b>3,27</b> (2,70)
	<b>Dešininis stačiakampis / kairinis apvalus latakų galas</b> 	140 mm		50	<b>3,27</b> (2,70)
	<b>P tipo (trumpas) stačiakampis DDC laikiklis</b> 	140 mm		25	<b>10,59</b> (8,75)
	<b>H tipo (kompaktiškas) stačiakampis DDC laikiklis</b> 	140 mm		30	<b>3,81</b> (3,15)
	<b>Ilgas stačiakampis laikiklis</b> 	140 mm		25	<b>11,74</b> (9,70)
	<b>P tipo (trumpas) apvalus DDC laikiklis</b> 	140 mm		25	<b>10,59</b> (8,75)
	<b>H tipo (kompaktiškas) apvalus DDC laikiklis</b> 	140 mm		30	<b>3,81</b> (3,15)
	<b>Ilgas apvalus laikiklis</b> 	140 mm		25	<b>11,74</b> (9,70)



**Siba Tech gilių latakų lietaus sistemos komponentai**

Kaina €/vnt. su PVM 21% (€/vnt. be PVM)



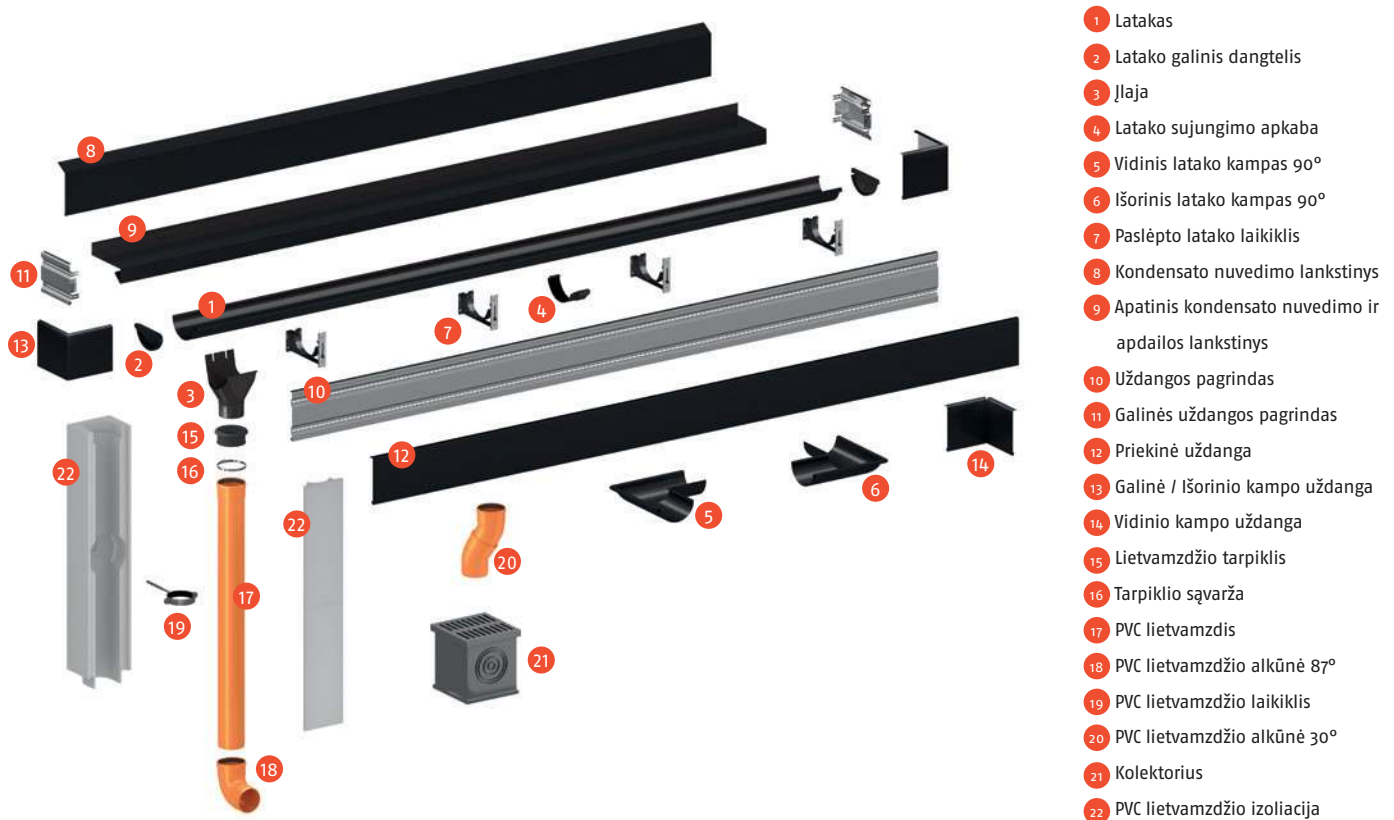

Vaizdas	Pavadinimas	Dydis	Ilgis	Kiekis pakuotėje	Kaina su PVM
	<b>Kvadratinis lietaus vamzdis</b> 	80 x 80 mm	3000 mm	2	<b>34,49</b> (28,50)
		80 x 80 mm	1000 mm	2	<b>12,34</b> (10,20)
	<b>Kvadratinio lietaus vamzdžio įlaja</b> 	140 / 80 x 80		20	<b>9,26</b> (7,65)
	<b>Kvadratinė viršutinė / apatinė alkūnė</b> 	80 x 80 mm		25	<b>7,74</b> (6,40)
	<b>Kvadratinio lietaus vamzdžio laikiklis</b> 	80 x 80 mm		20	<b>3,09</b> (2,55)
	<b>Apvalus lietaus vamzdis</b> 	90 mm	3000 mm	2	<b>31,34</b> (25,90)
		90 mm	1000 mm	2	<b>14,64</b> (12,10)
	<b>Apvalaus lietaus vamzdžio įlaja</b> 	140 / 90		20	<b>9,26</b> (7,65)
	<b>Apvalaus lietaus vamzdžio viršutinė alkūnė</b> 	90 mm		16	<b>7,02</b> (5,80)
	<b>Apvalaus lietaus vamzdžio apatinė alkūnė</b> 	90 mm		16	<b>8,23</b> (6,80)
	<b>Apvalaus lietaus vamzdžio laikiklis</b> 	90 mm		15	<b>3,09</b> (2,55)
	<b>Iššivalančioji lapų gaudyklė (plastikinė)</b> 			5	<b>25,05</b> (20,70)
	<b>Kvadratinio lietaus vamzdžio kolektorius*</b> 	Skirtas kvadratiniam lietaus vamzdžiui 80 x 80 mm		1	<b>47,80</b> (39,50)
	<b>Apvalaus lietaus vamzdžio kolektorius*</b> 	Skirtas apvaliam lietaus vamzdžiui 75, 90, 100		1	<b>47,80</b> (39,50)

\* Elementas pagamintas iš PVC







## Paslėptoji lietaus nuvedimo sistema









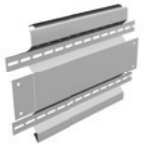
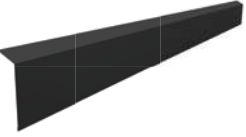
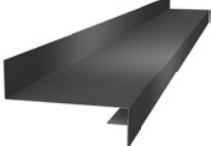

Kaina €/vnt. su PVM 21% (€/vnt. be PVM)

Vaizdas	Pavadinimas		Pastabos
	1. Latakas	150 mm    2,0 m	<b>22,51</b> (18,60)
		150 mm    4,0 m	<b>45,01</b> (37,20)
	3. Įlaja	150/100 mm	<b>16,36</b> (13,50)
	7. Paslėpto latako laikiklis	150 mm	<b>19,30</b> (15,95)
	4. Latako sujungimo apkaba	150 mm	<b>7,87</b> (6,50)
	6. Išorinis latako kampas 90°	150 mm	<b>19,60</b> (16,20)

Kaina €/vnt. su PVM 21% (€/vnt. be PVM)

Vaizdas	Pavadinimas	Pastabos	
	5. Vidinis latako kampas 90° 150 mm		<b>19,60</b> (16,20)
	2. Latako galinis dangtelis 150 mm		<b>7,20</b> (5,80)
	12. Priekinė uždanga L = 2400 mm	Ruukki® 50 Plus matt	<b>18,39</b> (15,20)
		Ruukki® 40	<b>17,55</b> (14,50)
	14. Vidinio kampo uždanga 210 x 210 mm	Ruukki® 50 Plus matt	<b>6,17</b> (5,10)
		Ruukki® 40	<b>5,69</b> (4,70)
	13. Išorinio kampo / galinė uždanga 210 x 210 mm	Ruukki® 50 Plus matt	<b>6,17</b> (5,10)
		Ruukki® 40	<b>5,69</b> (4,70)
	10. Uždangos pagrindas L = 2400 mm		<b>18,76</b> (15,50)
	11. Galinės uždangos pagrindas		<b>5,69</b> (4,70)
	8. Kondensato nuvedimo lankstinys L = 2400 mm	Ruukki® 50 Plus matt	<b>14,64</b> (12,20)
		Ruukki® 40	<b>14,04</b> (11,70)
	9. Apatinis kondensato nuvedimo ir apdailos lankstinys L = 2400 mm	Ruukki® 50 Plus matt	<b>21,06</b> (17,55)
		Ruukki® 40	<b>19,74</b> (16,45)

Kaina €/vnt. su PVM 21% (€/vnt. be PVM)

Vaizdas	Pavadinimas		Pastabos	
	17. PVC lietvamzdis	110 mm	3,0 m	<b>22,26</b> (18,40)
			1,0 m	<b>9,32</b> (7,70)
	19. PVC lietvamzdžio laikiklis	110 mm	90 mm	<b>4,60</b> (3,80)
			150 mm	<b>6,78</b> (5,60)
	18. PVC lietvamzdžio alkūnė 87°	110 mm		<b>5,08</b> (4,20)
	20. PVC alkūnė 30°	110 mm		<b>4,24</b> (3,50)
	22. PVC lietvamzdžio izoliacija Komplekte: pagrindas ir dangtelis		1,0 m	<b>9,08</b> (7,50)
	15. Lietvamzdžio tarpiklis	110 mm		<b>7,50</b> (6,20)
	16. Tarpiklio sąvarža	110 mm		<b>5,08</b> (4,20)
	21. Kolektorius	110 mm	200 x 200 x 200 mm	<b>52,03</b> (43,00)

#### Paslėptosios lietaus nuvedimo sistemos spalvos

RR22  
tik Ruukki 50 Plus Matt

RR23

RR2H3

RR33

## Stogo saugos elementai

### Stogo tilteliai



Kaina €/vnt. su PVM 21% (€/vnt. be PVM)

Vaizdas	Pavadinimas	Kodas	Pastabos	
	Stogo tiltelis	604530	600 mm	<b>43,74</b> (36,15)
		604520	1400 mm	<b>84,34</b> (69,70)
		604510	3000 mm	<b>149,07</b> (123,20)
	Sniego užtvaros ir stogo tiltelio tvirtinimo kojelės *	6050A	Monterrey, Adamante, Frigge, kaina už 2 vnt. komplektą	<b>37,21</b> (30,75)
		6050D	Finnera, kaina už 2 vnt. komplektą	<b>37,21</b> (30,75)
		6050E	T20, kaina už 2 vnt. komplektą	<b>37,21</b> (30,75)
	Sniego užtvaros ir tiltelio tvirtinimo kojelės UniSeam *	6050B	Classic, Valcinis profilis, kaina už 2 vnt. komplektą	<b>50,22</b> (41,50)
	Stogo tiltelio tvirtinimo plokštelės * (2 vnt. plokštelių)	60465	Reguliuojamas posvyrio kampas 5°–45° laipsniai	<b>20,69</b> (17,10)
	Universali atraminė plokštė sutapdintiems stogams		Įeina plokštė (576), varžtas (662) ir veržlė (663)	<b>24,88</b> (20,56)

\* Parduodama 2 kojelių pakuotėmis – komplektais. Komplekte yra visi reikalingi tvirtinimo ir sandarinimo elementai.

### Sniego užtvaros



Kaina €/vnt. su PVM 21% (€/vnt. be PVM)

Vaizdas	Pavadinimas	Kodas	Pastabos	
	Sniego užtvaros apvalus vamzdis (502)	60401	3000 mm, kaina už 1 vamzdį	<b>34,67</b> (28,65)
	Sniego užtvaros ir stogo tiltelio tvirtinimo kojelės *	6050A	Monterrey, Adamante, Frigge, kaina už 2 vnt. komplektą	<b>37,21</b> (30,75)
		6050D	Finnera, kaina už 2 vnt. komplektą	<b>37,21</b> (30,75)
		6050E	T20, kaina už 2 vnt. komplektą	<b>37,21</b> (30,75)
		6050C	Hyygge, kaina už 2 vnt. komplektą	<b>61,41</b> (50,75)
	Sniego užtvaros ir tiltelio tvirtinimo kojelės UniSeam *	6050B	Classic, Valcinis profilis, kaina už 2 vnt. komplektą	<b>50,22</b> (41,50)

\* Parduodama 2 kojelių pakuotėmis – komplektais. Komplekte yra visi reikalingi tvirtinimo ir sandarinimo elementai.

### SOLAR laikikliai









Kaina €/vnt. su PVM 21% (€/vnt. be PVM)

Vaizdas	Pavadinimas	Kodas	Pastabos	
	Saulės elementų laikiklis UniSeam (680+671)	60630	Classic ir valciniams profiliams	<b>14,58</b> (12,05)
	Saulės elementų laikiklis universalus (681+tarpinės)	60642	Trapeciniams ir čerpiniams profiliams	<b>18,88</b> (15,60)



## Kopėčios

Kaina €/vnt. su PVM 21% (€/vnt. be PVM)

Vaizdas	Pavadinimas	Kodas	Pastabos	
	<b>Kopėčios SafeGrip (400 mm pločio)</b>	60101012	1200 mm	<b>61,47</b> (50,80)
		60101027	2700 mm	<b>117,13</b> (96,80)
		60101033	3300 mm	<b>141,45</b> (116,90)
	<b>Stogo kopėčių kojelių ir tvirtinimo detalių komplektas As3/8</b> Komplekte: 4 poros kojelių, tarpinės, varžtai, sraigtai	60301	Adamante, Monterrey, Finnera, T20, Hyygge	<b>76,59</b> (63,30)
	<b>Stogo kopėčių kojelių ir centrinio tvirtinimo detalių komplektas UniSeam</b> Komplekte: 4 poros kojelių, 2 centrinio tvirtinimo detalės, 4 UniSeam fiksatoriai, tarpinės, varžtai, veržlės	60302	Classic ir valcinis profilis	<b>107,57</b> (88,90)
	<b>Papildomų kopėčių tvirtinimo kojelių komplektas*</b>	60310	Plieniniams, Classic ir Valciniams stogams	<b>13,43</b> (11,10)
	<b>Kopėčių tvirtinimo komplektas sienai (431)</b>	60122	Komplekte: 2 viršutiniai lankai (turėklai), 4 vnt. 1000 mm ilgio kojelės su apkabomis, 2 vnt. karnizo atotampos, 2 vnt. lankų sujungimo su kopėčiomis detalės, 2 vnt. lankų tvirtinimo prie stogo detalės, sraigtai, varžtai.	<b>213,81</b> (176,70)
	<b>Papildomos kopėčių tvirtinimo kojelės sienai 1000 (432)</b>	60121	Komplekte: 2 vnt. 1000 mm ilgio kojelės su apkabomis, sraigtai, varžtai	<b>66,49</b> (54,95)
	<b>Kopėčių lankų (turėklų) tvirtinimo prie tiltelio komplektas (414)</b>	60125		<b>18,63</b> (15,40)
	<b>Kopėčių turėklų apatinių lankų komplektas (433)</b>	60124		<b>71,05</b> (58,72)

## Kopėčios

Kaina €/vnt. su PVM 21% (€/vnt. be PVM)

Vaizdas	Pavadinimas	Kodas	Pastabos	
	Avarinių kopėčių tvirtinimo komplektas sienai (438)	60161		<b>60,68</b> (50,15)
	Avarinių kopėčių tvirtinimo kojelės sienai (437)	60162	pora, kojelių ilgis 200 mm	<b>21,66</b> (17,90)
	Sieninių kopėčių tvirtinimo detalė 60126 prie daugiasluoksnių plokščių (416)	60126		<b>166,98</b> (138,00)

## Apsauginės tvorelės

Kaina €/vnt. su PVM 21% (€/vnt. be PVM)

Vaizdas	Pavadinimas	Kodas	Pastabos	
	Apsauginė tvorelė be sniego užtvaros (2 vamzdžiai) L = 6.0 m H = 0.6 m	L3381	Profiliams	<b>453,75</b> (375,00)
		L3421	Valciniams	<b>496,10</b> (410,00)
		L3461	Classic	<b>514,25</b> (425,00)
	Apsauginė tvorelė su sniego užtvara (4 vamzdžiai) L = 6.0 m H = 0.6 m	L3391	Profiliams	<b>532,40</b> (440,00)
		L3431	Valciniams	<b>586,85</b> (485,00)
		L3471	Classic	<b>605,00</b> (500,00)
	Apsauginė tvorelė be sniego užtvaros (4 vamzdžiai) L = 6.0 m H = 1.2 m	L3401	Profiliams	<b>605,00</b> (500,00)
		L3441	Valciniams	<b>665,50</b> (550,00)
		L3481	Classic	<b>689,70</b> (570,00)
	Apsauginė tvorelė su sniego užtvara (6 vamzdžiai) L = 6.0 m H = 1.2 m	L3411	Profiliams	<b>665,50</b> (550,00)
		L3451	Valciniams	<b>738,10</b> (610,00)
		L3491	Classic	<b>762,30</b> (630,00)

### Stogo saugos elementų spalvos

Raudonos plytos (RR750)	Raudona (RR29)	Šokoladinė (RR887)	Tamsi ruda (RR32)	<b>Žalia</b> (RR11)	Balta (RR20)
Šviesi pilka (RR21)	Tamsi pilka (RR23)	Antracito (RR2H3)	Juoda (RR33)		

**NAUJIENA****SAFE LINE**

YouTube



## Apsaugai nuo kritimo – vielinio lyno sistema Ruukki SafeLine

Kaina €/vnt. su PVM 21% (€/vnt. be PVM)

Vaizdas	Pavadinimas	Kodas	Pastabos	
	SafeLine lino laikiklis	34300		<b>21,05</b> (17,40)
	SafeLine lino laikiklio komplektas	952	Komplekte laikiklis, 2 varžtai ir 2 veržlės	<b>21,66</b> (17,90)
	Lino laikiklio tvirtinimo prie kopėčių detalė	34301		<b>13,43</b> (11,10)
	SafeLine lino laikiklio komplektas kopėčioms	953	Komplekte laikiklis, laikiklio tvirtinimo prie kopėčių detalė, 2 varžtai ir 2 veržlės	<b>35,09</b> (29,00)
	Slankiklio stabdiklis kopėčioms	34303		<b>16,64</b> (13,75)
	Galinis slankiklio stabdiklis lino laikikliui	34306		<b>7,99</b> (6,60)
	Galinis lino laikiklis	34323		<b>10,65</b> (8,80)
	M8 flanšinis varžtas, 20 mm, ir M8 flanšinė veržlė	82443	Varžtas	<b>1,19</b> (0,98)
		82468	Veržlė	<b>0,85</b> (0,70)
	Galinė lino apsauga	34317		<b>12,34</b> (10,20)
	Slankiklis 8 mm plieniniam lynui	34318		<b>97,41</b> (80,50)
	8 mm nerūdijančio plieno lynas su galiniais elementais, reikiamo ilgio	34000–34029	1–30 m (kas metrą) Kaina už 1 m	Klausti pardavėjo
	8 mm nerūdijančio plieno lynas	34050	8 mm lynas, reikiamo ilgio < 50 m, kaina už 1 m	<b>12,71</b> (10,50)
		34250	8 mm lynas, 10 m	<b>127,05</b> (105,00)
		34251	8 mm lynas, 20 m	<b>199,65</b> (165,00)
		34252	8 mm lynas, 50 m	<b>411,40</b> (340,00)
	8 mm nerūdijančio plieno lynas ritėse	34253	8 mm lino ritė, 100 m	<b>798,60</b> (660,00)
		34254	8 mm lino ritė, 500 m	<b>3751,00</b> (3100,00)
		34255	8 mm lino ritė, 1 000 m	<b>7381,00</b> (6100,00)
		34256	8 mm lino ritė, 1 500 m	<b>11132,00</b> (9200,00)
		34257	8 mm lino ritė, reikiamo ilgio > 50 m, kaina už 1 m	Klausti pardavėjo

\* Visi SafeLine komponentai pagaminti iš nerūdijančio plieno.

# Profiliuoti lakštai

## Sienoms ir stogui

Kaina €/m<sup>2</sup> su PVM 21% (€/m<sup>2</sup> be PVM)

Vaizdas	Pavadinimas	Ruukki® 50 Plus	Ruukki® 40	Ruukki® 30 Plus	Ruukki® 30
	T20-79-1100 (sienoms) T20-24-1100 (sienoms) T20-24W-1100 (stogui)	21,18 (17,50)	18,39 (15,20)	14,40 (11,90)	13,07 (10,80)
	T45-30W-905 (stogui)	28,62 (23,65)	23,60 (19,50)	22,02 (18,20)	20,21 (16,70)
	T20 su antikondensaciniu veltiniu *	27,13 (22,42)	24,34 (20,12)	20,35 (16,82)	19,02 (15,72)
	T45 su antikondensaciniu veltiniu *	34,57 (28,57)	29,55 (24,42)	27,98 (23,12)	26,16 (21,62)

\* Antikondensacinis sluoksnis – vidinėje T20, T45 lakštų pusėje priklijuotas specialus Dripstop Original veltinis.

### DripStop privalumai

- Geresnės akustinės savybės (-2dB)
- Degumo klasė A2 – s1, d0
- Sugeria iki 1000 g/m<sup>2</sup> kondensato

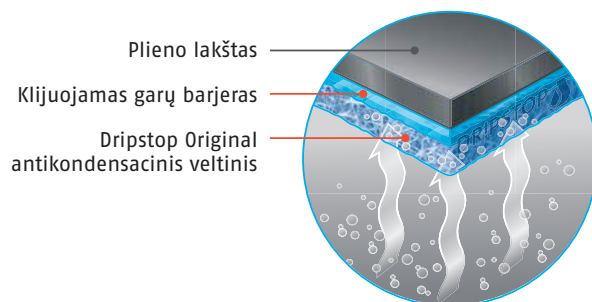
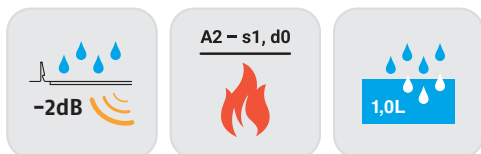



### Ruukki® 50 Plus Matt kokybės klasės spalvos

Raudonos plytos (RR750)	Raudona (RR29)	Šokolado ruda (RR887)	Tamsi ruda (RR32)	Tamsi žalia (RR11)	Šviesi pilka (RR21)
Pilka (RR22)	Tamsi pilka (RR23)	Antracito (RR2H3)	Juoda (RR33)		

### Ruukki® 30 kokybės klasės spalvos

Raudonos plytos (RR750)	Raudona (RR29)	Šokolado ruda (RR887)	Tamsi ruda (RR32)	Tamsi žalia (RR11)	Balta (RR20)
Šviesi pilka (RR21)	Pilka (RR22)	Tamsi pilka (RR23)	Antracito (RR2H3)	Juoda (RR33)	

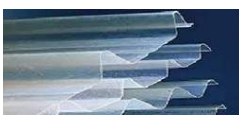
Kaina €/m<sup>2</sup> su PVM 21% (€/m<sup>2</sup> be PVM)

Vaizdas	Pavadinimas	Kodas	Pastabos
	Skaidrus lakštas T20-24W-1100 S	RA6T 5000 6903A1P20R	450 g/m <sup>2</sup> <b>26,26</b> (21,70)
	Skaidrus lakštas T45-30W-905	RA6T 5000 69039145R	450 g/m <sup>2</sup> <b>31,22</b> (25,80)

## Profiliuoti lakštai

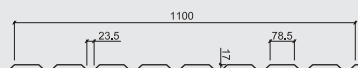
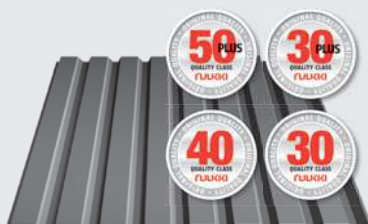

### T20-79-1100

Naudingas dengiamas plotis	1100 mm
Profilio aukštis	17 mm
Bendras plotis	1140 mm
Minimalus ilgis	500 mm
Maksimalus ilgis	10 000 mm
Viršūnės plotis	79 mm
Minimalus stogo nuolydis	11°
Lakšto storis	0.50 mm
Cinko kiekis	275 g/m <sup>2</sup>
Svoris	4.5 kg/m <sup>2</sup>

✓ Galimybė užsakyti su antikondensaciniu veltiniu

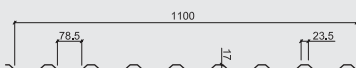
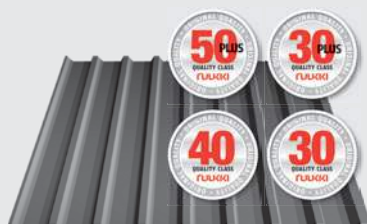

### T20-24-1100

Naudingas dengiamas plotis	1100 mm
Profilio aukštis	17 mm
Bendras plotis	1140 mm
Minimalus ilgis	500 mm
Maksimalus ilgis	10 000 mm
Viršūnės plotis	24 mm
Minimalus stogo nuolydis	11°
Lakšto storis	0.50 mm
Cinko kiekis	275 g/m <sup>2</sup>
Svoris	4.5 kg/m <sup>2</sup>

✓ Galimybė užsakyti su antikondensaciniu veltiniu

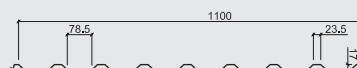
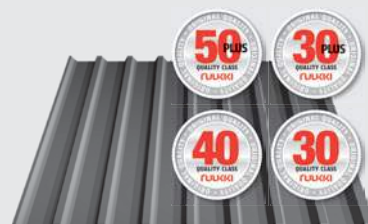

### T20-24W-1100

Naudingas dengiamas plotis	1100 mm
Profilio aukštis	17 mm
Bendras plotis	1140 mm
Minimalus ilgis	500 mm
Maksimalus ilgis	10 000 mm
Viršūnės plotis	24 mm
Minimalus stogo nuolydis	11°
Lakšto storis	0.50 mm
Cinko kiekis	275 g/m <sup>2</sup>
Svoris	4.5 kg/m <sup>2</sup>

✓ Galimybė užsakyti su antikondensaciniu veltiniu

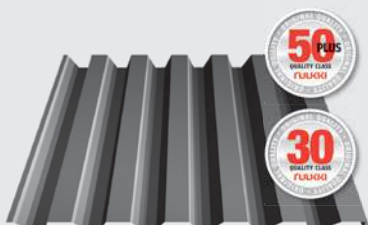

### T45-60-905

Naudingas dengiamas plotis	905 mm
Profilio aukštis	44 mm
Bendras plotis	960 mm
Minimalus ilgis	500 mm
Maksimalus ilgis	10 000 mm
Viršūnės plotis	60 mm
Minimalus stogo nuolydis	11°
Lakšto storis	0.50 mm
Cinko kiekis	275 g/m <sup>2</sup>
Svoris	5.42 kg/m <sup>2</sup>

✓ Galimybė užsakyti su antikondensaciniu veltiniu

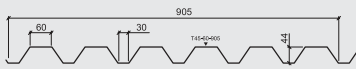
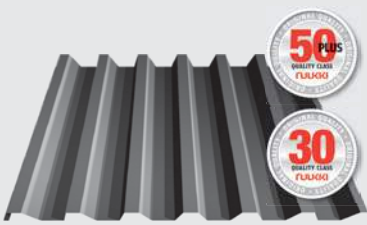

### T45-30-905

Naudingas dengiamas plotis	905 mm
Profilio aukštis	44 mm
Bendras plotis	960 mm
Minimalus ilgis	500 mm
Maksimalus ilgis	10 000 mm
Viršūnės plotis	30 mm
Minimalus stogo nuolydis	11°
Lakšto storis	0.50 mm
Cinko kiekis	275 g/m <sup>2</sup>
Svoris	5.42 kg/m <sup>2</sup>

✓ Galimybė užsakyti su antikondensaciniu veltiniu



### T45-30W-905

Naudingas dengiamas plotis	905 mm
Profilio aukštis	44 mm
Bendras plotis	960 mm
Minimalus ilgis	500 mm
Maksimalus ilgis	10 000 mm
Viršūnės plotis	30 mm
Minimalus stogo nuolydis	11°
Lakšto storis	0.50 mm
Cinko kiekis	275 g/m <sup>2</sup>
Svoris	5.42 kg/m <sup>2</sup>

✓ Galimybė užsakyti su antikondensaciniu veltiniu

## Profilis stogo pakalimams Soffit

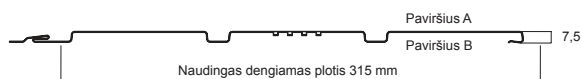
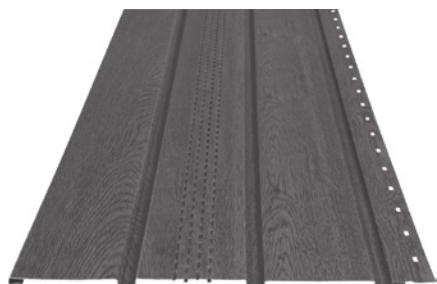

\* Galima užsakyti reikalingų ilgių lakštus

Profilio aukštis	7,5 mm
Cinko kiekis	275 g/m <sup>2</sup>
Minimalus ilgis	300 mm
Maksimalus ilgis	3 600 mm
Lakšto storis	0,5 mm
Naudingas dengiamas plotas	1,13 m <sup>2</sup> /vnt.
Lakštų skaičius pakuotėje	44 vnt.

Kaina €/m<sup>2</sup> su PVM 21% (€/m<sup>2</sup> be PVM)

Pavadinimas	Medžio imitacija	Ruukki 30 Plus Matt	Ruukki 30
<b>Soffit</b>	<b>28,07</b> (23,20)	<b>24,50</b> (20,25)	<b>23,29</b> (19,25)

Kaina €/vnt. su PVM 21% (€/vnt. be PVM)

Vaizdas	Pavadinimas	Kodas	Kokybės klasė	
	<b>Startinis elementas "J"</b>	305000418	Ruukki 30	<b>9,08</b> (7,90)
	2000 mm		Ruukki 30 Plus Matt	<b>9,56</b> (7,90)
			Medžio imitacija	<b>10,83</b> (8,95)
	<b>Vidinis kampas</b>	30500039707	Ruukki 30	<b>7,02</b> (5,80)
	<b>Išorinis kampas</b>	30500039807	Ruukki 30 Plus Matt	<b>7,62</b> (6,30)
	2000 mm		Medžio imitacija	<b>9,32</b> (7,70)
	<b>Nerūdijančio plieno sraigčiai Classic tvirtinimui</b>	RAS1WP4225PH2		<b>8,83</b> (7,30)
	4.2 x 25 mm			
	100 vnt./pak., AiSi			

### Galimos spalvos

Balta (RAL9010)	Šokoladinė (RR887)	Tamsiai pilka (RR23)	Antracito (RR2H3)	Juoda (RR33)	Ažuolo šviesi
--------------------	-----------------------	-------------------------	----------------------	-----------------	---------------

## Lygi skarda

Kaina €/m<sup>2</sup> su PVM 21% (€/m<sup>2</sup> be PVM)

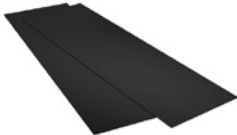
Vaizdas	Pavadinimas	Storis	Kokybės klasė, padengimas	
	Lygi skarda	0,50 mm	Ruukki® 50 Plus Matt	<b>18,27</b> (15,10)
		0,50 mm	Ruukki® 40	<b>16,09</b> (13,30)
		0,50 mm	Ruukki® 30 Plus Matt	<b>11,68</b> (9,65)
		0,50 mm	Ruukki® 30	<b>11,07</b> (9,15)
		0,50 mm	Zn	<b>11,07</b> (9,15)
		0,60 mm	Ruukki® 50 Plus Matt	<b>20,51</b> (16,95)

\* Apsauginė plėvelė lygiai skardai + 0,48 (0,40) €/m<sup>2</sup>

### Ruukki® 50 Plus Matt lygios skardos spalvos

Raudonos plytos (RR750)	Raudona (RR29)	Tamsi ruda (RR32)	Tamsi žalia (RR11)	Šviesi pilka (RR21)	Pilka (RR22)
Tamsi pilka (RR23)	Antracito (RR2H3)	Juoda (RR33)	Šokolado ruda (RR887)		

### Ruukki® 40 lygios skardos spalvos

Raudona (RR29)	Tamsi ruda (RR32)	Tamsi pilka (RR23)	Antracito (RR2H3)	Juoda (RR33)	Šokolado ruda (RR887)
-------------------	----------------------	-----------------------	----------------------	-----------------	--------------------------

### Ruukki® 30 Plus Matt lygios skardos spalvos

Raudona (RR29)	Tamsi ruda (RR32)	Tamsi pilka (RR23)	Antracito (RR2H3)	Juoda (RR33)	Šokolado ruda (RR887)
-------------------	----------------------	-----------------------	----------------------	-----------------	--------------------------

### Ruukki® 30 lygios skardos spalvos

Raudonos plytos (RR750)	Raudona (RR29)	Tamsi ruda (RR32)	Tamsi žalia (RR11)	Balta (RR20)	Šviesi pilka (RR21)
Pilka (RR22)	Tamsi pilka (RR23)	Antracito (RR2H3)	Juoda (RR33)	Šokolado ruda (RR887)	

## Lygi skarda TSP (plastiškas plienas)

Kaina €/vnt. su PVM 21% (€/vnt. be PVM)

Vaizdas	Pavadinimas	Storis	Kokybės klasė	
	Lygi skarda	0,60 mm	Ruukki® 50 Plus Matt	<b>22,69</b> (18,75)











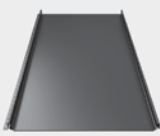
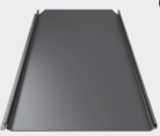
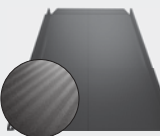
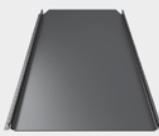
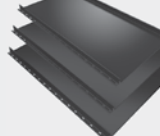
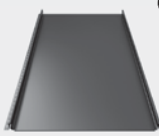
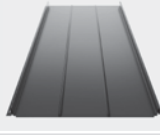

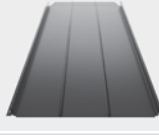
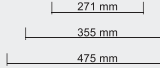















































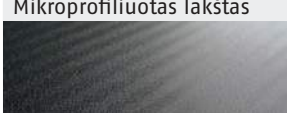

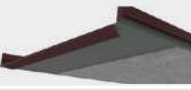

### Ruukki® 50 Plus Matt TSP lygios skardos spalvos

Raudona (RR29)	Tamsi ruda (RR32)	Šviesi pilka (RR21)	Tamsi pilka (RR23)	Antracito (RR2H3)
-------------------	----------------------	------------------------	-----------------------	----------------------

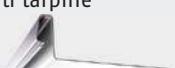

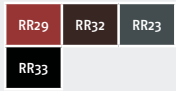
# Bendra Classic profilių savybių palyginimo lentelė

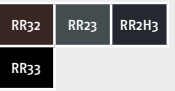

	<b>NAUJIENA</b>					
	Classic Economy Plus	Classic C/D	Classic M	Classic Authentic	Classic Design C	Classic NextGen
	 C	 C	 M	 C	 C	 C
	 D	 D		 D		
						
<b>Kokybės klasė</b>	<b>Ruukki® 30 Plus</b>	<b>Ruukki® 50 Plus</b>	<b>Ruukki® 50 Plus</b>	<b>Ruukki® 50 Plus</b>	<b>Ruukki® 50 Plus</b>	<b>Ruukki® 50 Plus</b>
Atsparumas UV spinduliams						
Atsparumas įbrėžimams						
Paviršiaus polimerinis padengimas	matinis	matinis	matinis	matinis	matinis	matinis
Garantija (techninė/estetinė)	30/10 metų	50/25 metų	50/25 metų	50/25 metų	50/25 metų	50/25 metų
Priekinio krašto užlenkimas 						
Uždengiami valcų galai 						
Mikroprofiluota tvirtinimo linija 						
Bet kuri montavimo kryptis 						
Lakšto storis <b>0,60 mm</b> 						
Mikroprofiluotas lakštas 						
Akustinis veltinis 	 * užsakant Silence	 * užsakant Silence	 * užsakant Silence	 * užsakant Silence		
Sujungimų sandarumą padidinanti tarpinė 						
Spalvos						

Ruukki Construction yra plieninių, stogams ir sienoms skirtų statybos produktų ir paslaugų tiekėja tvariems pastatams. Kurdami produktus tvirtai laikomės tvarumo, ilgaamžiškumo vertybinių nuostatų, esame sukaupę ilgalaikę patirtį plieno ir statybų pramonės srityse.

# RUUKKI

**Centrinis biuras** Pramonės g. 16, Vaidotai, 14149 Vilniaus raj.  
tel. (5) 232 23 15 [ruukki.lietuva@ruukki.com](mailto:ruukki.lietuva@ruukki.com)

**Kauno skyrius** Partizanų g. 63M, 50300 Kaunas  
tel. (37) 32 74 07 [kaunas@ruukki.com](mailto:kaunas@ruukki.com)

**Klaipėdos skyrius** Svajonės g. 38, 94101 Klaipėda  
tel. (46) 49 25 49 [klaipeda@ruukki.com](mailto:klaipeda@ruukki.com)

**Panevėžio skyrius** S. Kerbedžio g. 7A, 35104 Panevėžys  
tel. (45) 46 30 47 [panevezys@ruukki.com](mailto:panevezys@ruukki.com)

**Šiaulių skyrius** Metalistų g. 8F, 78136 Šiauliai  
tel. (41) 52 00 80 [siauliai@ruukki.com](mailto:siauliai@ruukki.com)

**Ruukki Products AS**

[www.ruukki.lt](http://www.ruukki.lt)

[www.ruukkistogas.lt](http://www.ruukkistogas.lt)

